



VICINO A TE

2024 Catalogo Generale

Think BIC

STRUMENTI DI SCRITTURA BIC®

PENNE A SFERA

BIC® Style	46
BIC® Round Stic®	50
BIC® M10® Clic	56
BIC® Media Clic	58
BIC® Media Clic Grip	63
BIC® Media Clic BGuard™ antibacterial	67
BIC® Media Clic BGuard™ antimicrobial Ecolutions®	70
BIC® Media Clic Biobased Ecolutions®	72
BIC® Media Clic Biobased BGuard™ antibacterial	75
BIC® Media Clic Shine	77
BIC® Media Clic Glacé	78
BIC® Clic Stic	80
BIC® Clic Stic Stylus	84
BIC® Clic Stic Mini	84
BIC® Super Clip	88
BIC® Super Clip Advance	94
BIC® Super Clip Glacé	98
BIC® Super Clip Glacé Advance	98
BIC® Super Clip Soft	100
BIC® Super Clip Soft Advance	100
BIC® Super Clip Origin	102
BIC® Wide Body™	104
BIC® 4 Colours®	112
BIC® 4 Colours® Bicolor	114
BIC® 4 Colours® Gradient	116
BIC® 4 Colours® Pastel	118
BIC® 4 Colours® Fashion	120
BIC® 4 Colours® Sun	122
BIC® 4 Colours® Fine	124
BIC® 4 Colours® Fluo	126
BIC® 4 Colours® Shine	128
BIC® 4 Colours® Glacé	130
BIC® 4 Colours® Soft	132
BIC® 4 Colours® Wood Style	134
BIC® 4 Colours® Flags Collection	136
BIC® 4 Colours® 3+1 ^{HB}	138

PENNE METALLICHE

BIC® Metal Pro	140
BIC® Cristal® Re'New™	145

ROLLER E GEL

BIC® Grip Roller	150
BIC® XS Finestyle	152
BIC® Intensity® Gel Clic	154

EVIDENZIATORI & PENNARELLI

BIC® Brite Liner® Grip	158
BIC® Velleda® White Board Marker Fine	160
BIC® Velleda® White Board Marker Grip	161
BIC® Mark-It Permanent Marker	162
BIC® Permanent Marker Ecolutions®	163

PORTAMINE

BIC® Matic®	166
BIC® Media Clic Portamine	168
BIC® Media Clic Grip Portamine	169

MATITE

BIC® Evolution® Ecolutions®	174
Sprout™ Matita in grafite	178

BIC® STYLE

**Riconoscibile facilmente
grazie al suo tappo
iconico.**

**BIC® Style offre un eccellente
rapporto qualità-prezzo.**



BIC® STYLE

1610 Opaco

Colore inchiostro



01/01

01/03

01/04

01/02

02/02

04

10

100%

Solo disponibile
con inchiostro nero

Solo disponibile
con inchiostro blu

Solo disponibile
con inchiostro nero

PRODOTTO E STAMPATO
NEGLI STABILIMENTI BIC

CONFORMITÀ
NORMATIVA

ISO
certified

IMPRIM'VERT®

IL PROGRAMMA UBICITY™
CONSENTE DI RICICLARE GLI
STRUMENTI DI SCRITTURA BIC

100% DI ELETTRICITÀ
PROVENIENTE DA FONTI
RINNOVABILI

**MODALITÀ
DI SCRITTURA**

PENNA A SFERA M
0.1 MM

**TECNICHE
DI STAMPA**

SERIGRAFIA

Vedere pagina 250 per una spiegazione dettagliata delle icone.

BIC® STYLE
1610 Clear
Colore inchiostro



92

87

88

89

8H

93

100%

Personalizzazione

BIC® STYLE

1610 Opaco

A SP: max. 1 col.

BIC® STYLE

1610 Clear

B SP: max. 1 col.

MOQ 500 pz.

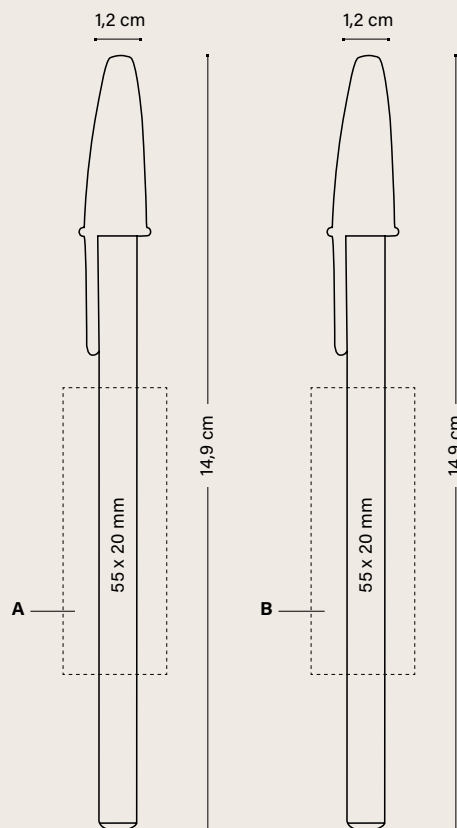

BIC® STYLE	500-999	1000-2499	2500-4999	Prezzo (€)
1610				5000
SP	0,48	0,43	0,41	0,39

Costo di stampa aggiuntivo per colore e posizione

SP	0,14	0,14	0,14	0,13
-----------	------	------	------	------

I prezzi includono serigrafia ad un colore in una posizione.

CONFEZIONI SPECIALI OPZIONALI | IMBALLAGGIO ESTERNO



PLASTIC
POUCH

+ INFO PAG. 240-245



500 ± 3,5 KG



PRODOTTO E STAMPATO
NEGLI STABILIMENTI BIC



CONFORMITÀ
NORMATIVA



ISO
certified



IMPRIM'VERT®



IL PROGRAMMA UBICITY™
CONSENTE DI RICICLARE GLI
STRUMENTI DI SCRITTURA BIC



100% DI ELETTRICITÀ
PROVENIENTE DA FONTI
RINNOVABILI

**MODALITÀ DI
SCRITTURA**



PENNA A SFERA M
Ø 1 MM

**TECNICHE
DI STAMPA**



SP
SERIGRAFIA

BIC® ROUND STIC®

**L'iconica BIC® Round Stic® offre
uno stile intramontabile ed alta
qualità.**

**Il suo design classico la rende
facilmente riconoscibile
ed è prova di una longeva
affidabilità.**





*l' iconico
BIC® Boy
è inciso*

BIC® ROUND STIC®

1010 Opaco

Colore inchiostro



Inchiostro rosso disponibile su richiesta



12



05



07



18



02



03



100%

Stampa a 360°

*Disponibile
in fusto bianco*



**MIX &
MATCH**



COLORI
PERSONALIZZATI



PRODOTTO E STAMPATO
NEGLI STABILIMENTI BIC



PRODOTTO
IN SPAGNA



CONFORMITÀ
NORMATIVA



ISO
certified



IMPRIM'VERT®



IL PROGRAMMA UBICITY™
CONSENTE DI RICICLARE GLI
STRUMENTI DI SCRITTURA BIC



100% DI ELETTRICITÀ
PROVENIENTE DA FONTI
RINNOVABILI

**MODALITÀ DI
SCRITTURA**



PENNA A SFERA M
Ø 1 MM

**TECNICHE
DI STAMPA**



SP
SERIGRAFIA



DG
DIGITALE

BIC® ROUND STIC®

1010 Frosted

Colore inchiostro



Inchiostro rosso disponibile su richiesta



Versione ECO.
Allo stesso prezzo della
versione standard!

ecolutions®



REALIZZATA CON IL 94%
DI MATERIALE RICICLATO*

VASSOI DI
FRUTTA
E VERDURA



BIC® ROUND STIC®

1E10 Opaco

Colore inchiostro



Inchiostro rosso disponibile su richiesta



1E/8E

1E/7E

1E/3E



100%

Disponibile
in fusto bianco



BIC® ROUND STIC®

1E10 Frosted

Colore inchiostro



Inchiostro rosso disponibile
su richiesta



2E/8E

2E/7E

2E/3E

2E/10E

100%

**MIX &
MATCH**



COLORI
PERSONALIZZATI



PRODOTTO E STAMPATO
NEGLI STABILIMENTI BIC



PRODOTTO
IN SPAGNA



CONFORMITÀ
NORMATIVA



IMPRIM'VERT®

ecolutions®



VASSOI DI
FRUTTA
E VERDURA



IL PROGRAMMA UBICITY™
CONSENTE DI RICICLARE GLI
STRUMENTI DI SCRITTURA BIC



100% DI ELETTRICITÀ
PROVENIENTE DA FONTI
RINNOVABILI

MODALITÀ DI
SCRITTURA



PENNA A SFERA M
Ø 1 MM

TECNICHE
DI STAMPA



SERIGRAFIA



DIGITALE

Vedere pagina 250 per una spiegazione dettagliata delle icone.

*La percentuale è calcolata sul peso totale del prodotto refill escluso. A causa del contenuto riciclato delle materie prime con cui è realizzato il prodotto, non siamo in grado di garantire che i colori che appaiono in catalogo, né quelli personalizzati su richiesta, abbiano sempre lo stesso colore e aspetto

BIC® ROUND STIC®

1010 / **ecolutions®** 1E10 Opaco
 1010 / **ecolutions®** 1E10 Frosted

MOQ 500 pz.
 Combinazione colori standard

ecolutions®



Combinazione colori standard*

Tappino

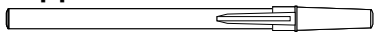

Cappuccio

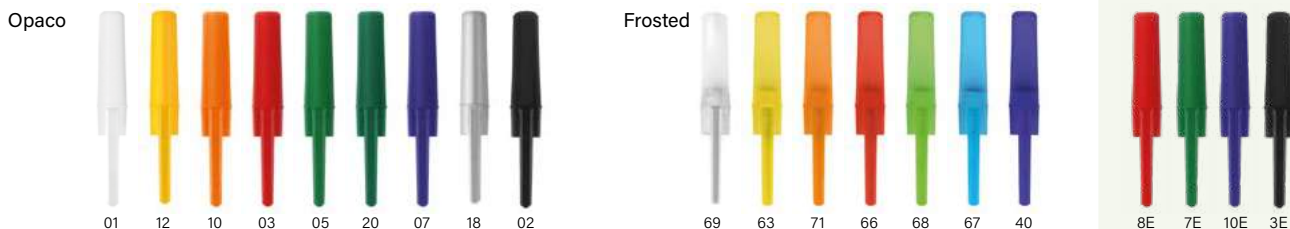
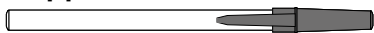

Sezione



Fusto



Esatta corrispondenza di colore: ≥ 10.000 unità



Aggiungi il Mobius loop alla tua grafica senza costi aggiuntivi. Si prega di specificarlo nell'ordine. La stampa del Mobius loop viene fatta di default nell'angolo a sinistra.

*A causa del contenuto riciclato delle materie prime con cui è realizzato il prodotto, non siamo in grado di garantire che i colori che appaiono in catalogo, né quelli personalizzati su richiesta, abbiano sempre lo stesso colore e aspetto

Personalizzazione

BIC® ROUND STIC®

1010

ecolutions® 1E10

A SP: max. 3 col.

B SP: max. 1 col.

C DG: full-colour

(Disponibile solo in fusto bianco)

MOQ 500 pz.

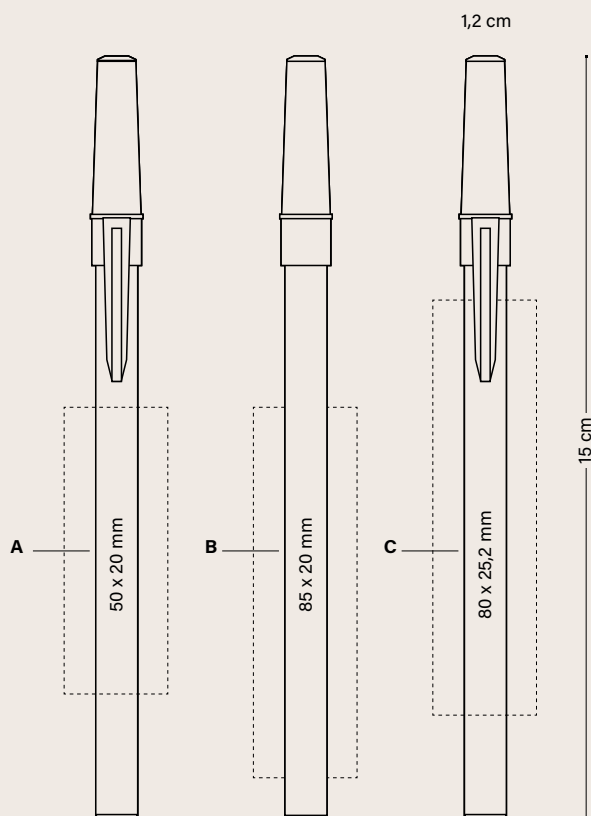

BIC® ROUND STIC®	500-999	1000-2499	2500-4999	Prezzo (€)
1010 / ecolutions® 1E10				5000
SP	0,53	0,51	0,47	0,44
DG	0,77	0,73	0,67	0,63

Costo di stampa aggiuntivo per colore e posizione

SP	0,14	0,14	0,14	0,13
----	------	------	------	------

I prezzi includono una stampa in una posizione secondo la tecnica specificata.

CONFEZIONI SPECIALI OPZIONALI



PLASTIC
POUCH

+ INFO PAG. 240-245

IMBALLAGGIO ESTERNO



500 ± 2,5 KG

MIX &
MATCH



COLORI
PERSONALIZZATI



PRODOTTO E STAMPATO
NEGLI STABILIMENTI BIC



PRODOTTO
IN SPAGNA



CONFORMITÀ
NORMATIVA



ISO
certified



IMPRIM'VERT®

ecolutions®



VASSOI DI
FRUTTA
E VERDURA



IL PROGRAMMA UBI-CYCITY™
CONSENTE DI RICICLARE GLI
STRUMENTI DI SCRITTURA BIC



100% DI ELETTRICITÀ
PROVENIENTE DA FONTI
RINNOVABILI

MODALITÀ DI SCRITTURA



PENNA A SFERA M
Ø 1 MM

TECNICHE DI STAMPA



SP
SERIGRAFIA



DG
DIGITALE

Vedere pagina 250 per una spiegazione dettagliata delle icone.



Iconico BIC® Boy
e logo BIC®
sempre visibili!

BIC® M10® CLIC

1590

Colore inchiostro



01

8G

10

14

59

04

02

3D

100%

●
Disponibile solo
in inchiostro nero

Personalizzazione

BIC® M10® CLIC
1590

A SP: max. 2 col.

MOQ 500 pz.

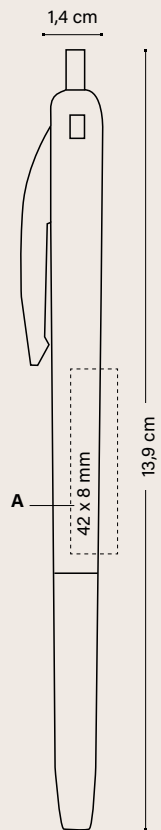

	Prezzo (€)			
BIC® M10® CLIC	500-999	1000-2499	2500-4999	5000
1590				
SP	0,60	0,58	0,54	0,50
Costo di stampa aggiuntivo per colore e posizione				
SP	0,14	0,14	0,14	0,13

I prezzi includono serigrafia ad un colore in una posizione.

CONFEZIONI SPECIALI OPZIONALI



+ INFO PAG. 240-245

IMBALLAGGIO ESTERNO



PRODOTTO E STAMPATO
NEGLI STABILIMENTI BIC



PRODOTTO IN FRANCIA



COLORE BIANCO
PRODOTTO IN SAF



CONFORMITÀ
NORMATIVA



ISO
certified



IL PROGRAMMA UBICITY™
CONSENTE DI RICICLARE GLI
STRUMENTI DI SCRITTURA BIC



100% DI ELETTRICITÀ
PROVENIENTE DA FONTI
RINNOVABILI

**MODALITÀ
DI SCRITTURA**



PENNA A SFERA M
Ø 1 MM

**TECNICHE
DI STAMPA**



SERIGRAFIA



GUARDA IL VIDEO

Vedere pagina 250 per una spiegazione dettagliata delle icone.





BIC® MEDIA CLIC



Uno dei bestseller del settore, dal design funzionale e ampiamente riconosciuto, la nostra BIC® Media Clic è un prodotto di lunga durata disponibile in diversi materiali. Scegli tra i modelli Standard, Riciclato, Biobased, Antibatterico e finiture premium. Lasciati ispirare dall'ampia gamma di finiture e colori e abbinali per valorizzare il tuo marchio.

ECOLUTIONS®

GRIP

GRIP ECOLUTIONS®

BGUARD™ ANTIBACTERIAL

BGUARD™ ANTIMICROBIAL

BIOBASED

BIOBASED BGUARD™ ANTIBACTERIAL

SHINE

GLACÉ



*l' iconico BIC® Boy
è inciso!*



*Anche in versione
Portamine*

BIC® MEDIA CLIC

1025 Penna a sfera / 1028 Portamine (vedere pagina 168)

Opaco

Colore inchiostro



Inchiostro rosso disponibile su richiesta



Versione ECO.
Allo stesso prezzo della versione
standard!

ecolutions®

**REALIZZATA CON IL 92%
DI MATERIALE RICICLATO***

**PARTI IN PLASTICA
PER AUTOVEICOLI**

BIC® MEDIA CLIC

1E25 Penna a sfera

Opaco

Colore inchiostro



**MIX &
MATCH**



COLORI
PERSONALIZZATI



PRODOTTO E STAMPATO
NEGLI STABILIMENTI BIC



PRODOTTO
IN SPAGNA



CONFORMITÀ
NORMATIVA



ISO
certified

IMPRIM'VERT®

ecolutions®



PARTI IN PLASTICA
PER AUTOVEICOLI



IL PROGRAMMA URICILITY™
CONSENTE DI RICICLARE GLI
STRUMENTI DI SCRITTURA BIC



100% DI ELETTRICITÀ
PROVENIENTE DA FONTI
RINNOVABILI

**MODALITÀ
DI SCRITTURA**



PENNA A SFERA M
Ø 1 MM

**TECNICHE
DI STAMPA**



SP
SERIGRAFIA



DG
DIGITALE

Vedere pagina 250 per una spiegazione dettagliata delle icone.

*La percentuale è calcolata sul peso totale del prodotto refill escluso. A causa del contenuto riciclato delle materie prime con cui è realizzato il prodotto, non siamo in grado di garantire che i colori che appaiono in catalogo, né quelli personalizzati su richiesta, abbiano sempre lo stesso colore e aspetto.



*Anche in versione
Portamine*

BIC® MEDIA CLIC

1025 Penna a sfera / 1028 Portamine (vedere pagina 168)

Frosted

Colore inchiostro



Inchiostro rosso disponibile su richiesta



BIC® MEDIA CLIC

1025 Penna a sfera

Clear

Colore inchiostro



4D

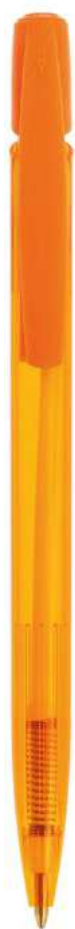

92



93

100%



Anche in versione
Portamine

BIC® MEDIA CLIC GRIP

1020 Penna a sfera

1021 Portamine (vedere pagina 169)

Opaco

Colore inchiostro



01/12

100%

Stampa a
360°

Disponibile
in fusto bianco



MIX &
MATCH



COLORI
PERSONALIZZATI



PRODOTTO E STAMPATO
NEGLI STABILIMENTI BIC



PRODOTTO
IN SPAGNA



CONFORMITÀ
NORMATIVA



IMPRIM'VERT®



IL PROGRAMMA UBICUITY™
CONSENTE DI RICICLARE GLI
STRUMENTI DI SCRITTURA BIC



100% DI ELETTRICITÀ
PROVENIENTE DA FONTI
RINNOVABILI

MODALITÀ
DI SCRITTURA



PENNA A SFERA M
Ø 1 MM

TECNICHE
DI STAMPA



SP
SERIGRAFIA



DG
DIGITALE

Vedere pagina 250 per una spiegazione dettagliata delle icone.

MIX & MATCH



COLORI PERSONALIZZATI



PRODOTTO E STAMPATO NEGLI STABILIMENTI BIC



PRODOTTO IN SPAGNA



CONFORMITÀ NORMATIVA



ISO certified



IMPRIMITIVO®

ecolutions®



PARTI IN PLASTICA PER AUTOVEICOLI



IL PROGRAMMA UBICITY™ CONSENTE DI RICICLARE GLI STRUMENTI DI SCRITTURA BIC



100% DI ELETTRICITÀ PROVENIENTE DA FONTI RINNOVABILI

MODALITÀ DI SCRITTURA



PENNA A SFERA M Ø 1 MM

TECNICHE DI STAMPA



SP SERIGRAFIA



DG DIGITALE



Anche in versione Portamine

BIC® MEDIA CLIC GRIP

1020 Penna a sfera

1021 Portamine (vedere pagina 169)

Frosted

Colore inchiostro



01/69



71/69



82/69



40/69

100%



Anche in versione Portamine

Versione ECO. Allo stesso prezzo della versione standard!

ecolutions®

REALIZZATA CON IL 92% DI MATERIALE RICICLATO*



PARTI IN PLASTICA PER AUTOVEICOLI

BIC® MEDIA CLIC GRIP

1E20 Penna a sfera

1E21 Portamine (vedere pagina 169)

Opaco

Colore inchiostro



01/03



01/05



01/02



01/07

100%

*La percentuale è calcolata sul peso totale del prodotto refill escluso. A causa del contenuto riciclato delle materie prime con cui è realizzato il prodotto, non siamo in grado di garantire che i colori che appaiono in catalogo, né quelli personalizzati su richiesta, abbiano sempre lo stesso colore e aspetto.

BIC® MEDIA CLIC / BIC® MEDIA CLIC GRIP

BIC® MEDIA CLIC

1025 Penna a sfera / **ecolutions®** 1E25 Penna a sfera

BIC® MEDIA CLIC GRIP

1020 Penna a sfera / **ecolutions®** 1E20 Penna a sfera

MOQ 500 pz.

ecolutions® Combinazione colori standard



Nessun costo aggiuntivo

Tappino



Opaco



Frosted



Clip



Opaco

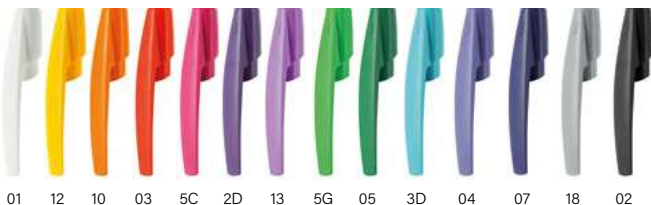

Frosted



Fusto



Opaco

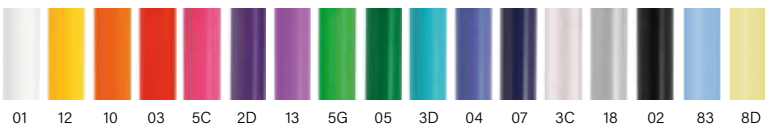

Corpo & Impugnatura



Frosted

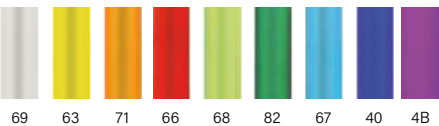

Corpo & Impugnatura

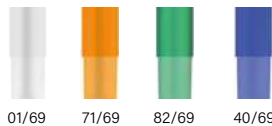

Clear

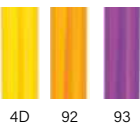

Esatta corrispondenza di colore: **≥ 10.000 pz. 1025/1E25**
 Esatta corrispondenza di colore: **≥ 20.000 pz. 1020/1E20**



Combinazione colori standard*

Opaco

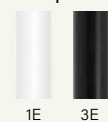

Corpo & Impugnatura Opaco

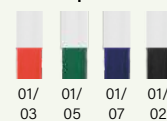

Aggiungi il Mobius loop alla tua grafica senza costi aggiuntivi. Si prega di specificarlo nell'ordine. La stampa del Mobius loop viene fatta di default nell'angolo a sinistra.

Vedere pagina 250 per una spiegazione dettagliata delle icone.



COLORI PERSONALIZZATI



PRODOTTO E STAMPATO NEGLI STABILIMENTI BIC



PARTI IN PLASTICA PER AUTOVEICOLI



IL PROGRAMMA UBICITY™ CONSENTE DI RICICLARE GLI STRUMENTI DI SCRITTURA BIC

MODALITÀ DI SCRITTURA



PENNA A SFERA M Ø 1 MM

TECNICHE DI STAMPA



SP SERIGRAFIA



DG DIGITALE

*A causa del contenuto riciclato delle materie prime con cui è realizzato il prodotto, non siamo in grado di garantire che i colori che appaiono in catalogo, né quelli personalizzati su richiesta, abbiano sempre lo stesso colore e aspetto.

BIC® MEDIA CLIC / BIC® MEDIA CLIC GRIP

Personalizzazione

BIC® MEDIA CLIC

1025 Penna a sfera
1028 Portamine (vedere pagina 168)
eColutions® 1E25 Penna a sfera

A SP: max. 4 col.
B SP: max. 2 col.
C DG: full-colour
MOQ 500 pz.

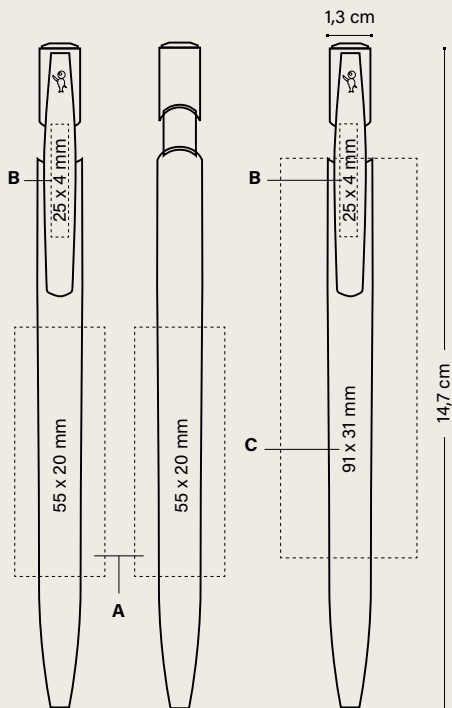

	Prezzo (€)			
BIC® MEDIA CLIC	500-999	1000-2499	2500-4999	5000
1025 / eColutions® 1E25 (Penne)				
SP	0,67	0,60	0,54	0,49
DG	0,97	0,87	0,76	0,67

Costo di stampa aggiuntivo per colore e posizione

SP	0,14	0,14	0,14	0,13
----	------	------	------	------

I prezzi includono una stampa in una posizione secondo la tecnica specificata.

CONFEZIONI SPECIALI OPZIONALI

IMBALLAGGIO ESTERNO



ECO SLEEVE

PLASTIC POUCH

WINDOW BOX

+ INFO PAG. 240-245



500 ± 41 KG

Personalizzazione

BIC® MEDIA CLIC GRIP

1020 Penna a sfera
1021 Portamine
(vedere pagina 169)
eColutions® 1E20 Penna a sfera
eColutions® 1E21 Portamine
(vedere pagina 169)

D SP: max. 4 col.
E SP: max. 2 col.
F DG: full-colour
MOQ 500 pz.

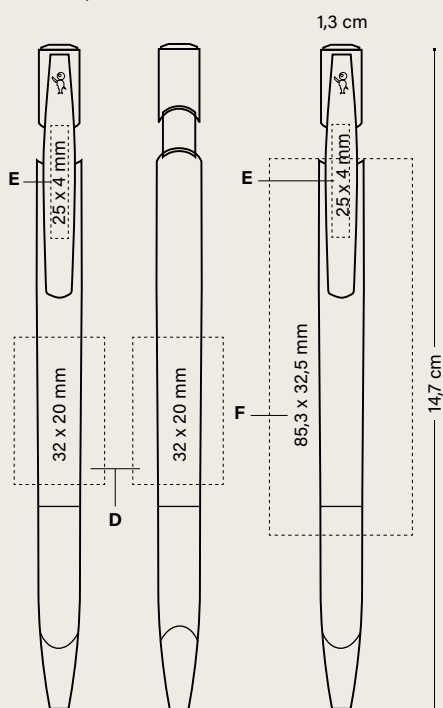

	Prezzo (€)			
BIC® MEDIA CLIC GRIP	500-999	1000-2499	2500-4999	5000
1020 / eColutions® 1E20 (Penne)				
SP	0,81	0,70	0,62	0,56
DG	1,04	0,97	0,83	0,74

Costo di stampa aggiuntivo per colore e posizione

SP	0,14	0,14	0,14	0,13
----	------	------	------	------

I prezzi includono una stampa in una posizione secondo la tecnica specificata.

CONFEZIONI SPECIALI OPZIONALI

IMBALLAGGIO ESTERNO



ECO SLEEVE

PLASTIC POUCH

WINDOW BOX

+ INFO PAG. 240-245



500 ± 4,3 KG



IL PROGRAMMA UBICITY™ CONSENTE DI RICICLARE GLI STRUMENTI DI SCRITTURA BIC

MODALITÀ DI SCRITTURA



PENNA A SFERA M Ø 1 MM

TECNICHE DI STAMPA



SERIGRAFIA



DIGITALE

BIC® MEDIA CLIC Antibacterial



Protezione
batterica



Protezione della
superficie della
penna a sfera



Protezione
permanente



Test di protocollo
antibatterico



1E27

1026

BIC® MEDIA CLIC BGUARD™ ANTIBACTERIAL

BGUARD™



Protezione batterica



Protezione della superficie della penna a sfera



Protezione permanente



Test di protocollo antibatterico



LA SOLUZIONE PER LA COMUNICAZIONE FULL COLOUR!

BIC® MEDIA CLIC BGUARD™ ANTIBACTERIAL

1026: logo antibacterial

1027: logo SARS-CoV-2

Opaco

Colore inchiostro



Inchiostro rosso disponibile su richiesta



1BG

2BG

MIX & MATCH

Nessun costo aggiuntivo

BIC® MEDIA CLIC BGUARD™ ANTIBACTERIAL

1026: logo antibacterial

1027: logo SARS-CoV-2

Opaco

MOQ 500 pz.

Combinazione colori standard

Tappino

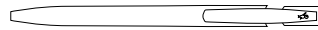

Opaco

1BG 7BG 2BG

Clip

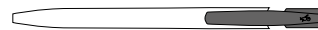

Opaco



1BG 2BG

Fusto



Opaco



1BG 2BG

Esatta corrispondenza di colore: ≥ 10.000 pz.



Iconico BIC® Boy e logo Antibacterial sempre visibili!

ANTIBACTERIAL™

Personalizzazione:

**BIC® MEDIA CLIC BGUARD™
ANTIBACTERIAL**

1026: logo antibacterial
1027: logo SARS-CoV-2

A **SP**: max. 2 col.
B **SP**: max. 1 col.
C **DG**: full-colour

MOQ 500 pz.

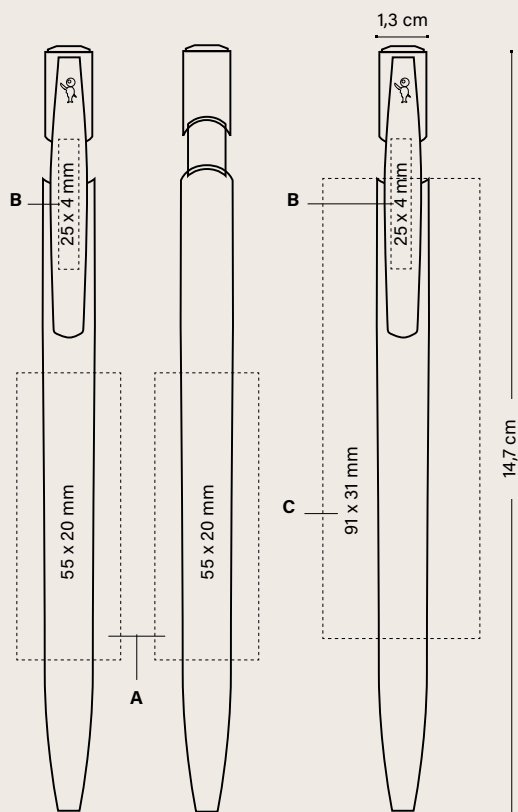

BIC® MEDIA CLIC BGUARD™ ANTIBACTERIAL	Prezzo (€)			
	500-999	1000-2499	2500-4999	5000
1026/1027				
SP	0,74	0,66	0,60	0,55
DG	1,03	0,94	0,82	0,73

Costo di stampa aggiuntivo per colore e posizione

SP	0,14	0,14	0,14	0,13
-----------	------	------	------	------

I prezzi includono una stampa in una posizione secondo la tecnica specificata.

CONFEZIONI SPECIALI OPZIONALI



ECO SLEEVE

+ INFO PAG. 240-245



PLASTIC POUCH



WINDOW BOX

IMBALLAGGIO ESTERNO



500 ± 4,1 KG

**MIX &
MATCH**



COLORI
PERSONALIZZATI



PRODOTTO E STAMPATO
NEGLI STABILIMENTI BIC



PRODOTTO
IN SPAGNA



CONFORMITÀ
NORMATIVA



ISO
certified



IMPRIM'VERT®



IL PROGRAMMA UBICUITY™
CONSENTE DI RICICLARE GLI
STRUMENTI DI SCRITTURA BIC



100% DI ELETTRICITÀ
PROVENIENTE DA FONTI
RINNOVABILI

**MODALITÀ
DI SCRITTURA**



PENNA A SFERA M
Ø 1 MM

**TECNICHE
DI STAMPA**



SERIGRAFIA



DIGITALE

Vedere pagina 250 per una spiegazione dettagliata delle icone.

BIC® MEDIA CLIC BGUARD™ ANTIMICROBIAL ECOLUTIONS®



ANTIMICROBIAL™* =



Protezione batterica 99% in 24h

+



93% di riduzione virale entro 24 ore

+



Inibizione di funghi 24 ore

BGUARD™ **ecolutions®**

MIX & MATCH

Nessun costo aggiuntivo

ecolutions®



REALIZZATA CON IL 86% DI MATERIALE RICICLATO**

PARTI IN PLASTICA PER AUTOVEICOLI



ecolutions®

PARTI IN PLASTICA PER AUTOVEICOLI



BIC® MEDIA CLIC BGUARD™ ANTIMICROBIAL ECOLUTIONS®

ecolutions® 1E26: logo antimicrobiale

ecolutions® 1E27: logo SARS-CoV-2

Opaco

Colore inchiostro



Inchiostro rosso disponibile su richiesta



BIC® MEDIA CLIC BGUARD™ ANTIMICROBIAL ECOLUTIONS®

ecolutions® 1E26 / ecolutions® 1E27



Aggiungi il Mobius loop alla tua grafica senza costi aggiuntivi. Si prega di specificarlo nell'ordine. La stampa del Mobius loop viene fatta di default nell'angolo a sinistra.

MOQ 500 pz.
Combinazione colori standard

Tappino

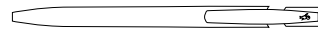

Opaco 1BG 7BG 2BG

Clip

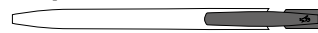

Opaco 1BG 2BG

Fusto



Opaco 1E 3E

Esatta corrispondenza di colore: ≥ 10.000 pz.



Puoi anche scegliere di stampare il logo SARS-CoV-2 REDUCTION. Per maggiori informazioni chiedi al tuo referente del servizio clienti.

*il 99,9% dei batteri è eliminato dalla superficie in 24 ore (e più del 30% in 2 ore)

Testato secondo il protocollo ISO 22196 adattato al reale uso della penna.

Il 93% dei virus, Sars-Cov-2 Coronavirus che causano la malattia da Covid-19, vengono eliminati dalla superficie in 24 ore (e circa il 50% in 2 ore).

Testato secondo il protocollo ISO 22196 adattato al reale uso della penna.

I funghi presenti sulla superficie vengono inibiti entro 24 ore.

Testato secondo il protocollo ISO 22196 adattato al reale uso della penna.



Protezione della superficie della penna a sfera



Protezione permanente



Test di protocollo antibatterico



Conforme al Protocollo di test funghi



Protocollo test antivirale

Personalizzazione

BIC® MEDIA CLIC Bguard™ ANTIMICROBIAL ECOLUTIONS®

ecolutions® 1E26: logo antimicrobico

ecolutions® 1E27: logo SARS-CoV-2

A SP: max. 2 col.

B SP: max. 2 col.

MOQ 500 pz.

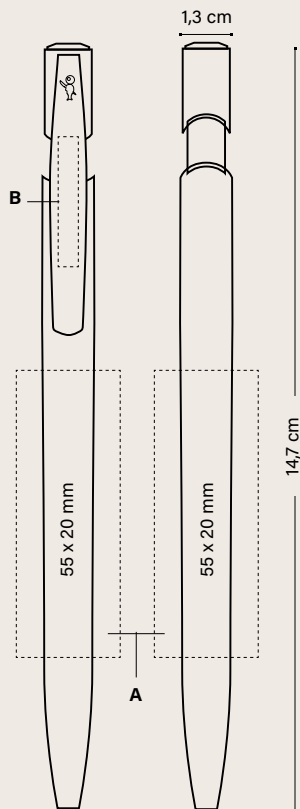

	Prezzo (€)			
BIC® MEDIA CLIC Bguard™ ANTIMICROBIAL	500-999	1000-2499	2500-4999	5000
ecolutions® 1E26 / ecolutions® 1E27				
SP	0,80	0,73	0,67	0,59

Costo di stampa aggiuntivo per colore e posizione

SP	0,14	0,14	0,14	0,13
-----------	------	------	------	------

I prezzi includono serigrafia ad un colore in una posizione.

CONFEZIONI SPECIALI OPZIONALI



ECO SLEEVE

+ INFO PAG. 240-245



PLASTIC POUCH



WINDOW BOX

IMBALLAGGIO ESTERNO



500 ± 4,1 KG



COLORI PERSONALIZZATI



PRODOTTO E STAMPATO NEGLI STABILIMENTI BIC



PRODOTTO IN SPAGNA



CONFORMITÀ NORMATIVA



IMPRIM'VERT®

ecolutions®



PARTI IN PLASTICA PER AUTOVEICOLI



IL PROGRAMMA UBICITY™ CONSENTE DI RICICLARE GLI STRUMENTI DI SCRITTURA BIC



100% DI ELETTRICITÀ PROVENIENTE DA FONTI RINNOVABILI

MODALITÀ DI SCRITTURA



PENNA A SFERA M 0,1 MM

TECNICHE DI STAMPA



SERIGRAFIA

Vedere pagina 250 per una spiegazione dettagliata delle icone.

Disponibile in paesi selezionati, chiedere al rappresentante del servizio clienti

**La percentuale è calcolata sul peso totale del prodotto refill escluso. A causa del contenuto riciclato delle materie prime con cui è realizzato il prodotto, non siamo in grado di garantire che i colori che appaiono in catalogo, né quelli personalizzati su richiesta, abbiano sempre lo stesso colore e aspetto.

BIC® MEDIA CLIC
BIOBASED ECOLUTIONS®

ecolutions®
BIOBASED

La sostenibilità è la sua priorità

Fatta per durare:

- Più di 10.000 clic!
- Maggiore visibilità al tuo archivio
- Clip infrangibile



PENNA DI ORIGINE BIOLOGICA

Hai finito l'inchiostro della penna?
Nessun problema, è compostabile*.

Il fusto è **100% Biobased**.



100 % elettricità da fonti rinnovabili

L'energia per la produzione e la stampa
nelle nostre strutture deriva al **100%**
da fonti rinnovabili



Basso impatto di trasporto:

Produzione, stampa e anche materie prime.



**100%
Riciclabile**
Ubicity™

Il fusto é
composto al
70%
da materiale
base bio**

I COLORANTI
SONO AL
100%
Bio

BIOBASED ecolutions®

BIOBASED

IL FUSTO È COMPOSTO AL 70%
DA MATERIALE BASE BIO*.
I COLORANTI SONO AL 100% BIO.



CANNA DA ZUCCHERO

ecolutions®

BIC® MEDIA CLIC BIOBASED ECOLUTIONS®

1972 Penna a sfera

Opaco

Colore inchiostro



Inchiostro rosso disponibile su richiesta



←
Sempre visibili!

Stampa a 360°

12BIO

03BIO

04BIO

02BIO

05BIO

01BIO

Disponibile
in fusto bianco



MIX & MATCH



COLORI PERSONALIZZATI



PRODOTTO E STAMPATO NEGLI STABILIMENTI BIC



PRODOTTO IN SPAGNA



CONFORMITÀ NORMATIVA



IMPRIM'VERT® ecolutions®



CANNA DA ZUCCHERO



IL PROGRAMMA URICITY™ CONSENTE DI RICICLARE GLI STRUMENTI DI SCRITTURA BIC



100% DI ELETTRICITÀ PROVENIENTE DA FONTI RINNOVABILI

MODALITÀ DI SCRITTURA



PENNA A SFERA M Ø 1 MM

TECNICHE DI STAMPA



SERIGRAFIA



DIGITALE

Vedere pagina 250 per una spiegazione dettagliata delle icone.

*La percentuale è calcolata sul peso totale del prodotto refill escluso, biodegradabile in condizioni industriali. A causa del contenuto naturale delle materie prime con cui è realizzato il prodotto, non siamo in grado di garantire che i colori che appaiono in catalogo, né quelli personalizzati su richiesta, abbiano sempre lo stesso colore e aspetto.

BIC® MEDIA CLIC BIOBASED ECOLUTIONS®



Nessun costo aggiuntivo

BIC® MEDIA CLIC BIOBASED ECOLUTIONS®

1972 Penna a sfera Opaco

MOQ 500 pz.
Combinazione colori standard

Tappino



Clip

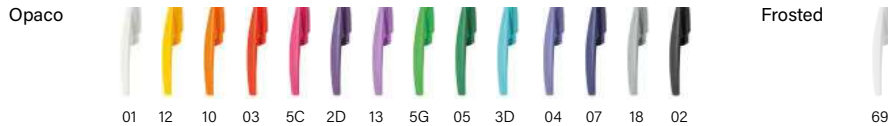

Fusto

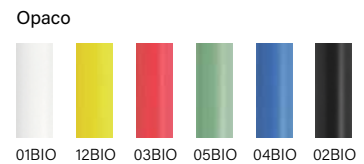

Esatta corrispondenza di colore:
≥ 10.000 pz.



PRODOTTO E STAMPATO
NEGLI STABILIMENTI BIC



PRODOTTO IN SPAGNA



CANNA DA
ZUCCHERO



IL PROGRAMMA UBICUITY™
CONSENTE DI RICICLARE GLI
STRUMENTI DI SCRITTURA BIC

MODALITÀ DI SCRITTURA



PENNA A SFERA M
Ø 1 MM

TECNICHE DI STAMPA



SERIGRAFIA



DIGITALE

Personalizzazione

BIC® MEDIA CLIC BIOBASED ECOLUTIONS®

1972

A SP: max. 2 col.

B SP: max. 2 col.

C DG: full-colour

MOQ 500 pz.

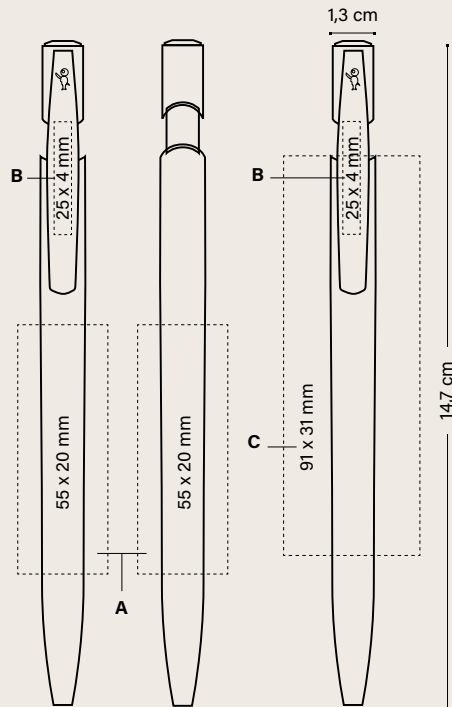

Prezzo (€)

BIC® MEDIA CLIC BIOBASED	500-999	1000-2499	2500-4999	5000
--------------------------	---------	-----------	-----------	------

ecolutions® 1972

SP	0,80	0,74	0,67	0,62
DG	1,13	1,03	0,90	0,84

Costo di stampa aggiuntivo per colore e posizione

SP	0,14	0,14	0,14	0,13
----	------	------	------	------

I prezzi includono una stampa in una posizione secondo la tecnica specificata.

CONFEZIONI SPECIALI OPZIONALI



ECO
SLEEVE



PLASTIC
POUCH



WINDOW
BOX



IMBALLAGGIO ESTERNO

500 ± 4,3KG

+ INFO PAG. 240-245

*A causa del contenuto naturale delle materie prime con cui è realizzato il prodotto, non siamo in grado di garantire che i colori che appaiono in catalogo, né quelli personalizzati su richiesta, abbiano sempre lo stesso colore e aspetto.

BIC® MEDIA CLIC BIOBASED BGUARD™ ANTIBACTERIAL

BGUARD™



Protezione batterica



Protezione della superficie della penna a sfera



Protezione permanente



Test di protocollo antibatterico

BIOBASED

IL FUSTO È COMPOSTO AL 70%
DA MATERIALE BASE BIO*
I COLORANTI SONO AL 100% BIO.



CANNA DA ZUCCHERO

BIC® MEDIA CLIC BIOBASED BGUARD™ ANTIBACTERIAL

1973 Penna a sfera

Opaco

Colore inchiostro



Inchiostro rosso disponibile su richiesta



02



01

Stampa a 360°

100%

Disponibile in fusto bianco



MIX & MATCH



COLORI PERSONALIZZATI



PRODOTTO E STAMPATO NEGLI STABILIMENTI BIC



PRODOTTO IN SPAGNA



CONFORMITÀ NORMATIVA



IMPRIM'VERT*



CANNA DA ZUCCHERO



IL PROGRAMMA URICITY™ CONSENTE DI RICICLARE GLI STRUMENTI DI SCRITTURA BIC



100% DI ELETTRICITÀ PROVENIENTE DA FONTI RINNOVABILI

MODALITÀ DI SCRITTURA



PENNA A SFERA M Ø 1 MM

TECNICHE DI STAMPA



SERIGRAFIA



DIGITALE

Vedere pagina 250 per una spiegazione dettagliata delle icone.

*La percentuale è calcolata sul peso totale del prodotto refill escluso, biodegradabile in condizioni industriali. A causa del contenuto naturale delle materie prime con cui è realizzato il prodotto, non siamo in grado di garantire che i colori che appaiono in catalogo, né quelli personalizzati su richiesta, abbiano sempre lo stesso colore e aspetto.

BIC® MEDIA CLIC BIOBASED BGUARD™ ANTIBACTERIAL

BGUARD™

ecolutions®*



CANNA DA ZUCCHERO

MIX & MATCH

Nessun costo aggiuntivo

BIC® MEDIA CLIC BIOBASED BGUARD™ ANTIBACTERIAL

1973 Penna a sfera Opaco

MOQ 500 pz. Combinazione colori standard.

Tappino

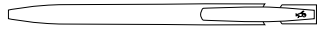

Opaco

01BG 07BG 02BG

Clip



Opaco



01BG 02BG

Fusto



Opaco



01 02

Esatta corrispondenza di colore: ≥ 10.000 pz.



MIX & MATCH



COLORI PERSONALIZZATI



PRODOTTO E STAMPATO NEGLI STABILIMENTI BIC



PRODOTTO IN SPAGNA

ecolutions®



CANNA DA ZUCCHERO



IL PROGRAMMA UBICUITY™ CONSENTE DI RICICLARE GLI STRUMENTI DI SCRITTURA BIC

MODALITÀ DI SCRITTURA



PENNA A SFERA M Ø 1 MM

TECNICHE DI STAMPA



SERIGRAFIA



DIGITALE

Personalizzazione

BIC® MEDIA CLIC BIOBASED BGUARD™ ANTIBACTERIAL

1973

A SP: max. 2 col.

B SP: max. 2 col.

C DG: full-colour

MOQ 500 pz.

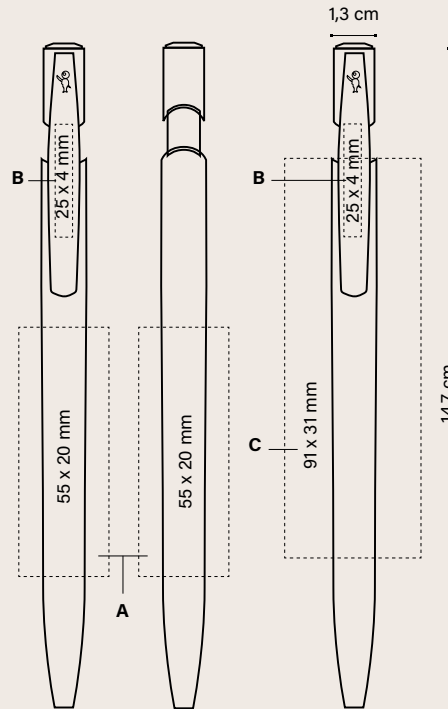

Prezzo (€)

BIC® MEDIA CLIC BIOBASED BGUARD™ ANTIBACTERIAL	500-999	1000-2499	2500-4999	5000
--	---------	-----------	-----------	------

ecolutions® 1973

SP	0,89	0,83	0,73	0,68
DG	1,34	1,19	1,05	0,94

Costo di stampa aggiuntivo per colore e posizione

SP	0,14	0,14	0,14	0,13
----	------	------	------	------

I prezzi includono una stampa in una posizione secondo la tecnica specificata.

CONFEZIONI SPECIALI OPZIONALI



+ INFO PAG. 240-245

IMBALLAGGIO ESTERNO



250 ± 4,3 KG

BIC® MEDIA CLIC SHINE

BIC® MEDIA CLIC SHINE

1975 Penna a sfera Opaco

MOQ 500 pz. Combinazione colori standard.



Nessun costo aggiuntivo

Tappino

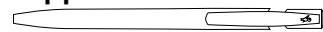

Opaco

01 12 10 03 5C 2D 13 84 5G 05 3D 04 07 18 02

Frosted

69

PREMIUM

35

Clip



Opaco

01 12 10 03 5C 2D 13 5G 05 3D 04 07 18 02

Frosted

69

Fusto



Shine

26 47

BIC® MEDIA CLIC SHINE

1975 Penna a sfera

Opaco

Colore inchiostro



Inchiostro rosso disponibile su richiesta



47



26

100%

BIC® MEDIA CLIC SHINE

1975

A SP: max. 2 col.

B SP: max. 2 col.

MOQ 500 pz.

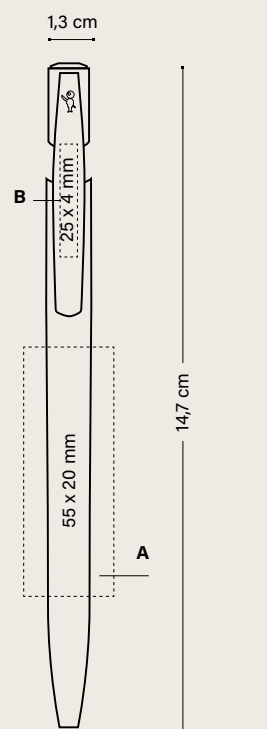

Prezzo (€)

BIC® MEDIA CLIC SHINE 500-999 1000-2499 2500-4999 5000

1975

SP 1,70 1,47 1,33 1,23

SP (premium) 1,85 1,62 1,46 1,35

Costo di stampa aggiuntivo per colore e posizione

SP 0,14 0,14 0,14 0,13

I prezzi includono serigrafia ad un colore in una posizione.

CONFEZIONI SPECIALI OPZIONALI



+ INFO PAG. 233 & 233

IMBALLAGGIO ESTERNO



500 ± 4,1 KG



COLORI PERSONALIZZATI



PRODOTTO E STAMPATO NEGLI STABILIMENTI BIC



PRODOTTO IN SPAGNA



CONFORMITÀ NORMATIVA



IMPRIM'VERT®



IL PROGRAMMA UBICITY™ CONSENTE DI RICICLARE GLI STRUMENTI DI SCRITTURA BIC



100% DI ELETTRICITÀ PROVENIENTE DA FONTI RINNOVABILI

MODALITÀ DI SCRITTURA



PENNA A SFERA M 0.1 MM

TECNICHE DI STAMPA



SP SERIGRAFIA

Vedere pagina 250 per una spiegazione dettagliata delle icone.

BIC® MEDIA CLIC GLACÉ

Il nostro best seller in abito elegante

BIC® MEDIA CLIC GLACÉ

1030 Opaco

Colore inchiostro



Inchiostro rosso disponibile su richiesta



47G



76



03G



05G



04G



14G

BIC® MEDIA CLIC GLACÉ

1030 Penna a sfera Opaco

MOQ 500 pz.
Combinazione colori standard

Tappino

Opaco 01 12 10 03 5C 2D 13 84 5G 05 3D 04 07 18 02 Frosted 69

Clip

Opaco 01 12 10 03 5C 2D 13 5G 05 3D 04 07 18 02 Frosted 69

Fusto

Opaco 47G 76 03G 14G 05G 04G

Personalizzazione

BIC® MEDIA CLIC GLACÉ

1030

A SP: max. 2 col.

B SP: max. 2 col.

MOQ 500 pz.

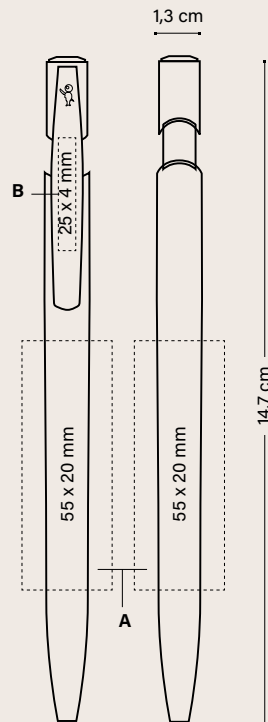

BIC® MEDIA CLIC GLACÉ	Prezzo (€)			
	500-999	1000-2499	2500-4999	5000
1030				
SP	1,05	0,90	0,78	0,70

Costo di stampa aggiuntivo per colore e posizione

SP	0,14	0,14	0,14	0,13
----	------	------	------	------

I prezzi includono serigrafia ad un colore in una posizione.

CONFEZIONI SPECIALI OPZIONALI



ECO SLEEVE



PLASTIC POUCH



WINDOW BOX



500 ± 4,1 KG

IMBALLAGGIO ESTERNO



PRODOTTO E STAMPATO NEGLI STABILIMENTI BIC



PRODOTTO IN SPAGNA



CONFORMITÀ NORMATIVA



IL PROGRAMMA UBICITY™ CONSENTE DI RICICLARE GLI STRUMENTI DI SCRITTURA BIC



100% DI ELETTRICITÀ PROVENIENTE DA FONTI RINNOVABILI

MODALITÀ DI SCRITTURA



PENNA A SFERA M Ø 1 MM

TECNICHE DI STAMPA



SERIGRAFIA

+ INFO PAG. 240-245

Vedere pagina 250 per una spiegazione dettagliata delle icone.

BIC® CLIC STIC

Moderna, flessibile, affidabile.

Ecco com'è

BIC® Clic Stic !

Una grande varietà di
finiture come
Digital, Stylus, Softfeel®
o Mini,



*Migliaia di
combinazioni di
colori!*



L' iconico BIC® Boy è inciso!

BIC® CLIC STIC

1000 Opaco

Colore inchiostro



12 05 04 07 02 03



Stampa a 360°

100%

Disponibile in fusto bianco



Versione ECO.
Allo stesso prezzo della versione standard!

ecolutions®

VASSOI DI FRUTTA E VERDURA



REALIZZATA CON IL 78% DI MATERIALE RICICLATO*

BIC® CLIC STIC

1E00 Opaco

Colore inchiostro



1E/8E 1E/7E 1E/3E 1E/10E



Stampa a 360°

100%

Disponibile in fusto bianco



MIX & MATCH



COLORI PERSONALIZZATI



PRODOTTO E STAMPATO NEGLI STABILIMENTI BIC



PRODOTTO IN SPAGNA



CONFORMITÀ NORMATIVA



IMPRIM'VERT®



VASSOI DI FRUTTA E VERDURA



IL PROGRAMMA UBICUTY™ CONSENTE DI RICICLARE GLI STRUMENTI DI SCRITTURA BIC



100% DI ELETTRICITÀ PROVENIENTE DA FONTI RINNOVABILI

MODALITÀ DI SCRITTURA



PENNA A SFERA M Ø 1 MM

TECNICHE DI STAMPA



SERIGRAFIA



DIGITALE

Vedere pagina 250 per una spiegazione dettagliata delle icone.

*La percentuale è calcolata sul peso totale del prodotto refill escluso. A causa del contenuto riciclato delle materie prime con cui è realizzato il prodotto, non siamo in grado di garantire che i colori che appaiono in catalogo, né quelli personalizzati su richiesta, abbiano sempre lo stesso colore e aspetto.

Versione ECO.
Allo stesso prezzo della
versione standard!

ecolutions®
REALIZZATA CON
IL 78% DE MATERIAL
RECICLADO*



BIC® CLIC STIC

1000 Frosted

Colore inchiostro



Inchiostro rosso disponibile su richiesta



69

63

71

66

68

40

67

100%

BIC® CLIC STIC

1E00 Frosted

Colore inchiostro



Inchiostro rosso disponibile
su richiesta



2E/8E

2E/10E

2E/3E

2E/7E

100%

* La percentuale è calcolata sul peso totale del prodotto refill escluso. A causa del contenuto riciclato delle materie prime con cui è realizzato il prodotto, non siamo in grado di garantire che i colori che appaiono in catalogo, né quelli personalizzati su richiesta, abbiano sempre lo stesso colore e aspetto.

**BIC® CLIC STIC
SOFTFEEL®**

1005 Opaco

Colore inchiostro



*Inchiostro rosso
disponibile su richiesta*



20



07



02
100%

**BIC® CLIC STIC
SOFTFEEL®**

1005 Frosted

Colore inchiostro



*Inchiostro rosso
disponibile su
richiesta*



40
100%

**MIX &
MATCH**



COLORI
PERSONALIZZATI



PRODOTTO E STAMPATO
NEGLI STABILIMENTI BIC



PRODOTTO IN SPAGNA



CONFORMITÀ
NORMATIVA



IMPRIM'VERT®

ecolutions®



VASSOI DI FRUTTA
E VERDURA



IL PROGRAMMA UBICITY™
CONSENTE DI RICICLARE GLI
STRUMENTI DI SCRITTURA BIC



100% DI ELETTRICITÀ
PROVENIENTE DA FONTI
RINNOVABILI

**MODALITÀ
DI SCRITTURA**



PENNA A SFERA M
Ø 1 MM

**TECNICHE
DI STAMPA**



SP
SERIGRAFIA



DG
DIGITALE

Vedere pagina 250 per una spiegazione dettagliata delle icone.

MIX & MATCH



COLORI PERSONALIZZATI



PRODOTTO E STAMPATO NEGLI STABILIMENTI BIC



PRODOTTO IN SPAGNA



CONFORMITÀ NORMATIVA



ISO certified



IMPRIM'VERT®



VASSOI DI FRUTTA E VERDURA



IL PROGRAMMA UBI-CITY™ CONSENTE DI RICICLARE GLI STRUMENTI DI SCRITTURA BIC



100% DI ELETTRICITÀ PROVENIENTE DA FONTI RINNOVABILI

MODALITÀ DI SCRITTURA



PENNA A SFERA M Ø 1 MM

TECNICHE DI STAMPA



SP SERIGRAFIA



DG DIGITALE

Versione ECO.
Allo stesso prezzo della versione standard!

ecolutions®

REALIZZATA CON IL 78% DI MATERIALE RICICLATO*



VASSOI DI FRUTTA E VERDURA

BIC® CLIC STIC STYLUS

1847 Opaco

Colore inchiostro



Inchiostro rosso disponibile su richiesta

BIC® CLIC STIC STYLUS

1846 Opaco

Colore inchiostro



Inchiostro rosso disponibile su richiesta

BIC® CLIC STIC MINI

1892 Opaco

Colore inchiostro



Inchiostro rosso disponibile su richiesta



Disponibile in fusto bianco



* La percentuale è calcolata sul peso totale del prodotto refill escluso. A causa del contenuto riciclato delle materie prime con cui è realizzato il prodotto, non siamo in grado di garantire che i colori che appaiono in catalogo, né quelli personalizzati su richiesta, abbiano sempre lo stesso colore e aspetto.

BIC® CLIC STIC

1000 Opaco / **ecolutions®** 1E00 Opaco
 1000 Frosted / **ecolutions®** 1E00 Frosted
 1005 Opaco / Frosted
 MOQ 500 pz. Combinazione colori standard

BIC® CLIC STIC STYLUS

1846 / 1847 Opaco

BIC® CLIC STIC MINI

1892 Opaco

**MIX &
MATCH**

Nessun costo aggiuntivo

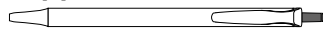
Tappino

Opaco

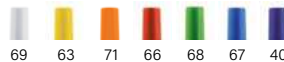

Frosted

**Clip**

Opaco

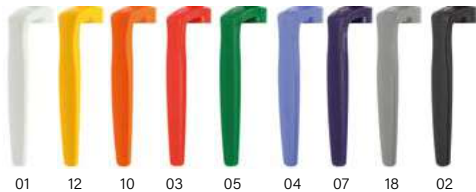

Frosted

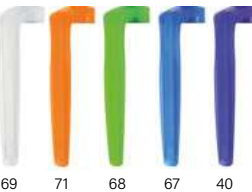
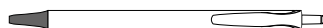
**Sezione**

Opaco

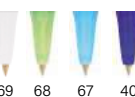

Frosted

**Stylus**

Opaco

**Fusto**

Opaco

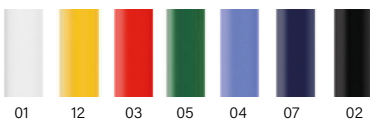
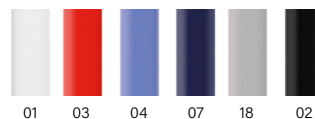
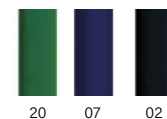
**Stylus****Softfeel®****Mini**

Frosted

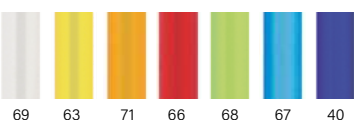

40

Esatta corrispondenza di colore: ≥ 10.000 pz.

ecolutions®

MOQ 500 pz.

ecolutions® Combinazione colori standard*



Aggiungi il Mobius loop alla tua grafica senza costi aggiuntivi. Si prega di specificarlo nell'ordine. La stampa del Mobius loop viene fatta di default nell'angolo a sinistra.

VASSOI DI FRUTTA
E VERDURA

**Tappino**

Opaco

**Sezione**

Opaco

**Stylus**

Opaco

**Clip**

Opaco

**Fusto**

Opaco

**Stylus**

Opaco



Esatta corrispondenza di colore: ≥ 10.000 pz.

*A causa del contenuto riciclato delle materie prime con cui è realizzato il prodotto, non siamo in grado di garantire che i colori che appaiono in catalogo, né quelli personalizzati su richiesta, abbiano sempre lo stesso colore e aspetto.



COLORI
PERSONALIZZATI



PRODOTTO E STAMPATO
NEGLI STABILIMENTI BIC



PRODOTTO IN SPAGNA



CONFORMITÀ
NORMATIVA



VASSOI DI
FRUTTA E
VERDURA



IL PROGRAMMA UBICLIVITY™
CONSENTE DI RICICLARE GLI
STRUMENTI DI SCRITTURA BIC



100% DI ELETTRICITÀ
PROVENIENTE DA FONTI
RINNOVABILI

**MODALITÀ
DI SCRITTURA**



PENNA A SFERA M
Ø 1 MM

**TECNICHE
DI STAMPA**



SERIGRAFIA



DIGITALE

Personalizzazione

BIC® CLIC STIC

1000 / **ecolutions**® 1E00

BIC® CLIC STIC STYLUS

1847 / **ecolutions**® 1846

A SP: max. 3 col.

B SP: max. 1 col.

C SP: max. 2 col.

D DG: full-colour (area per il testo)
(Disponibile solo in fusto bianco)

MOQ 500 pz.

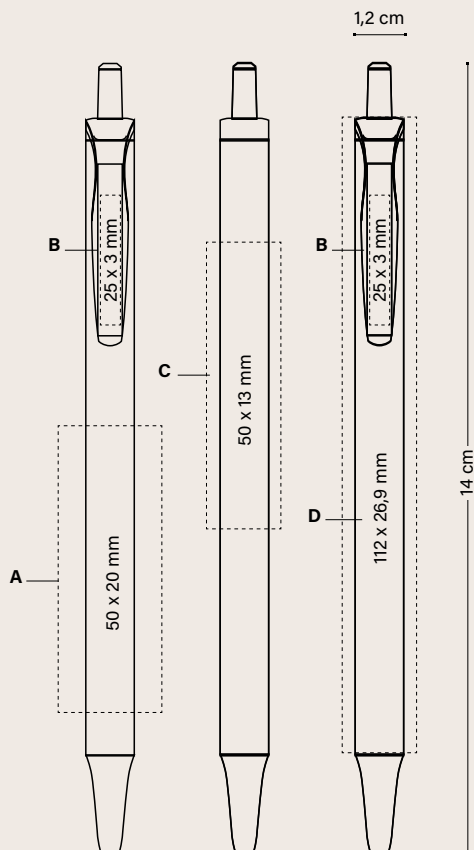

	500-999	1000-2499	2500-4999	Prezzo (€)
BIC® CLIC STIC				5000
1000 / ecolutions ® 1E00				
SP	0,85	0,74	0,70	0,66
DG	1,14	1,02	0,96	0,90
1847 / ecolutions ® 1846				
SP	1,02	0,91	0,85	0,77
DG	1,31	1,15	1,08	1,02

Costo di stampa aggiuntivo per colore e posizione

SP	0,14	0,14	0,14	0,13
----	------	------	------	------

I prezzi includono una stampa in una posizione secondo la tecnica specificata.

CONFEZIONI SPECIALI OPZIONALI



ECD
SLEEVE



PLASTIC
POUCH

+ INFO PAG. 240-245

IMBALLAGGIO ESTERNO



500 ± 2,9 KG

Personalizzazione

BIC® CLIC STIC SOFTFEEL®
1005

A/B SP: max. 1 col.

MOQ 500 pz.

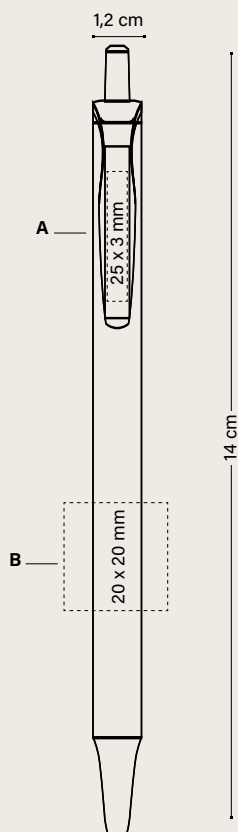

Prezzo (€)

BIC® CLIC STIC SOFTFEEL®	500-999	1000-2499	2500-4999	5000
1005				
SP	1,05	0,94	0,88	0,80

Costo di stampa aggiuntivo per colore e posizione

SP	0,14	0,14	0,14	0,13
----	------	------	------	------

I prezzi includono serigrafia ad un colore in una posizione.

CONFEZIONI SPECIALI OPZIONALI



+ INFO PAG. 240-245

IMBALLAGGIO ESTERNO



500 ± 2,9 KG

Personalizzazione

BIC® CLIC STIC MINI
1892

A SP: max. 1 col.

B SP: max. 1 col.

C DG: full-colour (area per il testo)
(Disponibile solo in fusto bianco)

MOQ 500 pz.

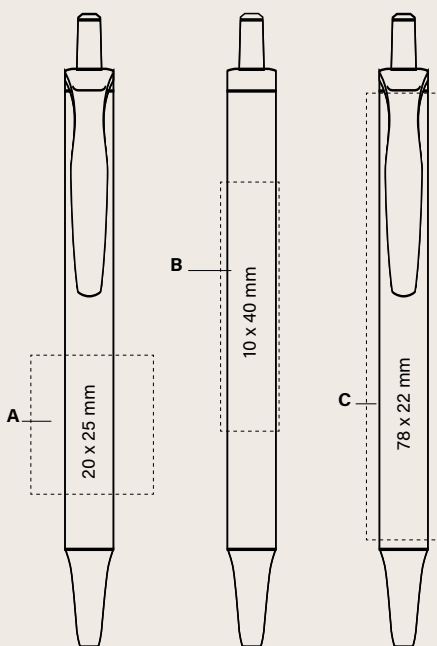

Prezzo (€)

BIC® CLIC STIC MINI	500-999	1000-2499	2500-4999	5000
1892				
SP	0,78	0,64	0,60	0,57
DG	1,06	0,95	0,88	0,82

I prezzi includono una stampa in una posizione secondo la tecnica specificata.

CONFEZIONI SPECIALI OPZIONALI



+ INFO PAG. 240-245

IMBALLAGGIO ESTERNO



500 ± 2,4 KG

MIX & MATCH



COLORI PERSONALIZZATI



PRODOTTO E STAMPATO NEGLI STABILIMENTI BIC



PRODOTTO IN SPAGNA



CONFORMITÀ NORMATIVA



IMPRIM'VERT®



IL PROGRAMMA UBICITY™ CONSENTE DI RICICLARE GLI STRUMENTI DI SCRITTURA BIC



100% DI ELETTRICITÀ PROVENIENTE DA FONTI RINNOVABILI

MODALITÀ DI SCRITTURA



PENNA A SFERA M Ø 1 MM

TECNICHE DI STAMPA



SERIGRAFIA



DIGITALE





BIC[®] SUPER CLIP

Scopri l'accattivante clip e il suo fluido meccanismo twist. La grande area di stampa XXL offre un'ampia gamma di possibilità di personalizzazione nelle versioni standard e advance. Ora disponibile anche nelle versioni soft e glacé. Inoltre, la BIC[®] Super Clip Origin è la prima penna a sfera di una nuova fase più innovativa e sostenibile. Benvenuti nel futuro!

ECOLUTIONS[®]
ADVANCE
GLACÉ
GLACÉ ADVANCE
SOFT
SOFT ADVANCE
ORIGIN

BIC® SUPER CLIP

BIC® SUPER CLIP

1039 Opaco

Colore inchiostro



Area di
stampa
XXL!



Meccanismo
twist fluido!

Stampa a 360°

Disponibile
in fusto bianco



Versione ECO. Allo stesso prezzo della versione standard!

ecolutions®



REALIZZATA CON IL 78% DI MATERIALE RICICLATO*



PARTI IN PLASTICA PER AUTOVEICOLI

BIC® SUPER CLIP

1E50 Opaco

Colore inchiostro



1E

BIC® SUPER CLIP

1039 Clear

Colore inchiostro



51



87



86



89



88

MIX & MATCH



COLORI PERSONALIZZATI



PRODOTTO E STAMPATO NEGLI STABILIMENTI BIC



PRODOTTO IN SPAGNA



CONFORMITÀ NORMATIVA



ISO certified



IMPRIM'VeRT®

ecolutions®



PARTI IN PLASTICA PER AUTOVEICOLI



IL PROGRAMMA UBICITY™ CONSENTE DI RICICLARE GLI STRUMENTI DI SCRITTURA BIC



100% DI ELETTRICITÀ PROVENIENTE DA FONTI RINNOVABILI

MODALITÀ DI SCRITTURA



PENNA A SFERA M Ø 1 MM

TECNICHE DI STAMPA



SERIGRAFIA



DIGITALE



BRITEPIX™
BRITEPIX™ TEXTURE
BRITEPIX™ PERSONALISATION

*La percentuale è calcolata sul peso totale del prodotto refill escluso. A causa del contenuto riciclato delle materie prime con cui è realizzato il prodotto, non siamo in grado di garantire che i colori che appaiono in catalogo, né quelli personalizzati su richiesta, abbiano sempre lo stesso colore e aspetto.

BIC® SUPER CLIP

BIC® SUPER CLIP

1039 Opaco

ecolutions® 1E50 Opaco

1039 Clear

MOQ 250 pz.

Combinazione colori standard



Nessun costo aggiuntivo

Clip



Opaco

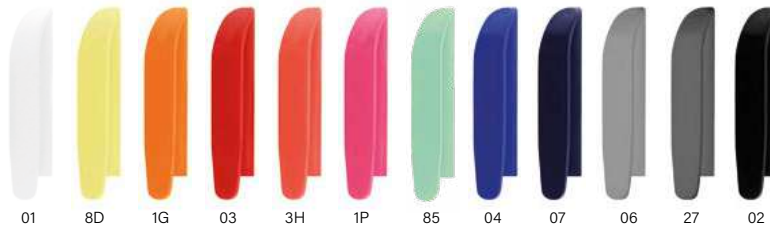

Clear

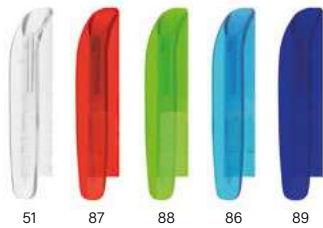

ecolutions®



PARTI IN PLASTICA
PER AUTOVEICOLI

Combinazione
colori standard*



1E 1E



Aggiungi il Mobius loop alla tua grafica senza costi aggiuntivi. Si prega di specificarlo nell'ordine. La stampa del Mobius loop viene fatta di default nell'angolo a sinistra.

Fusto



Opaco

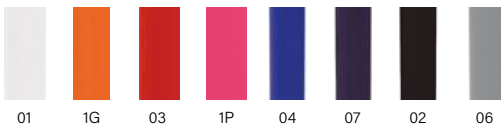

Clear

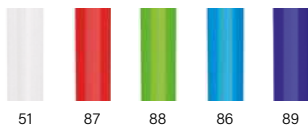

Esatta corrispondenza di colore: ≥ 10.000 pz.



*A causa del contenuto riciclato delle materie prime con cui è realizzato il prodotto, non siamo in grado di garantire che i colori che appaiono in catalogo, né quelli personalizzati su richiesta, abbiano sempre lo stesso colore e aspetto.

Personalizzazione

BIC® SUPER CLIP

1039

ecolutions® 1E50

A SP: max. 2 col.

B SP: max. 1 col.

C DG: full-colour

D BP: full-colour

BP Texture: full-colour

MOQ 250 pz.

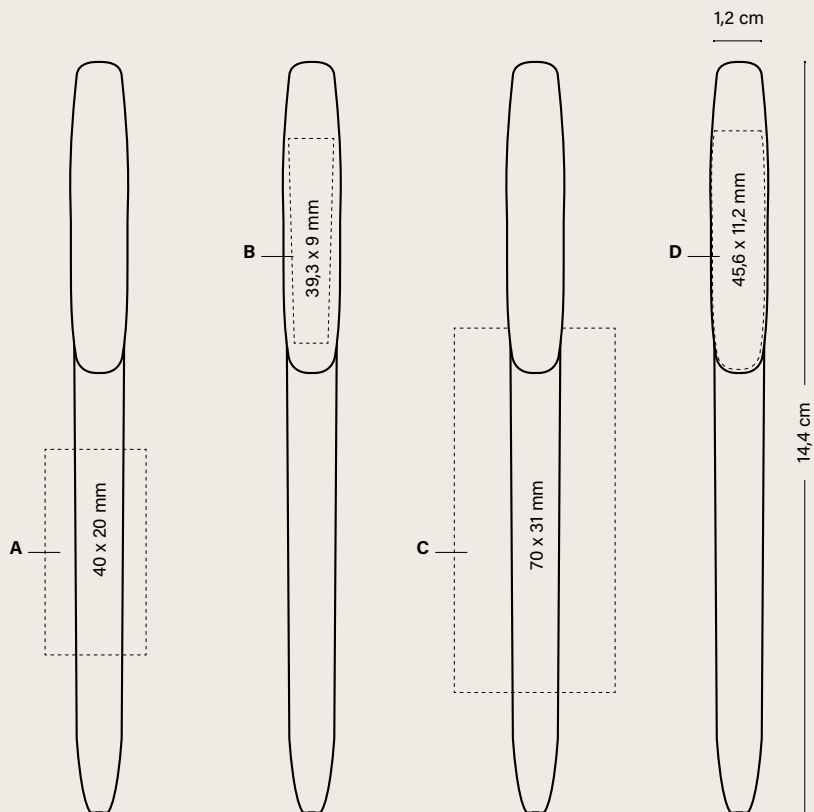

BIC® SUPER CLIP 1039 / ecolutions® 1E50	Prezzo (€)				
	250-499	500-999	1000-2499	2500-4999	5000
SP	1,13	1,02	0,95	0,88	0,84
DG	1,47	1,32	1,24	1,16	1,04
BP	1,41	1,28	1,19	1,12	0,99

Costo di stampa aggiuntivo per colore e posizione

SP	0,17	0,14	0,14	0,14	0,13
BP	0,24	0,22	0,21	0,20	0,19
BP Texture	0,18	0,16	0,15	0,15	0,14

I prezzi includono una stampa in una posizione secondo la tecnica specificata.

CONFEZIONI SPECIALI OPZIONALI



+ INFO PAG. 240-245

IMBALLAGGIO ESTERNO



250 ± 2,6 KG

Collection Box
(1, 2 e 3 pz.)

MIX &
MATCH



COLORI
PERSONALIZZATI



PRODOTTO E STAMPATO
NEGLI STABILIMENTI BIC



PRODOTTO IN SPAGNA



CONFORMITÀ
NORMATIVA



ISO
certified



IMPRIM'VERT®

ecolutions®



PARTI IN PLASTICA
PER AUTOVEICOLI



IL PROGRAMMA UBICITY™
CONSENTE DI RICICLARE GLI
STRUMENTI DI SCRITTURA BIC



100% DI ELETTRICITÀ
PROVENIENTE DA FONTI
RINNOVABILI

MODALITÀ DI SCRITTURA



PENNA A SFERA M
01 MM

TECNICHE DI STAMPA



SP
SERIGRAFIA



DG
DIGITALE



BRITEPIX™
BRITEPIX™ TEXTURE
BRITEPIX™
PERSONALISATION

Vedere pagina 250 per una spiegazione dettagliata delle icone.

BIC® SUPER CLIP ADVANCE

1073 Opaco

Colore inchiostro





06/35

02/35

1P/35

01/35

Disponibile
in fusto bianco



MIX & MATCH



COLORI
PERSONALIZZATI



PRODOTTO E STAMPATO
NEGLI STABILIMENTI BIC



PRODOTTO IN SPAGNA



CONFORMITÀ
NORMATIVA



IMPRIM'VERT®



IL PROGRAMMA UBICITY™
CONSENTE DI RICICLARE GLI
STRUMENTI DI SCRITTURA BIC



100% DI ELETTRICITÀ
PROVENIENTE DA FONTI
RINNOVABILI

**MODALITÀ
DI SCRITTURA**



PENNA A SFERA M
Ø 1 MM

**TECNICHE
DI STAMPA**



SERIGRAFIA



DIGITALE



BRITEPIX™
BRITEPIX™ TEXTURE
BRITEPIX™
PERSONALISATION

Vedere pagina 250 per una spiegazione dettagliata delle icone.

BIC® SUPER CLIP ADVANCE

BIC® SUPER CLIP ADVANCE

1073 Opaco

MOQ 250 pz.
Combinazione colori standard

**MIX &
MATCH**

Nessun costo aggiuntivo

Clip

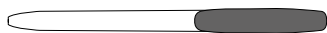

Opaco

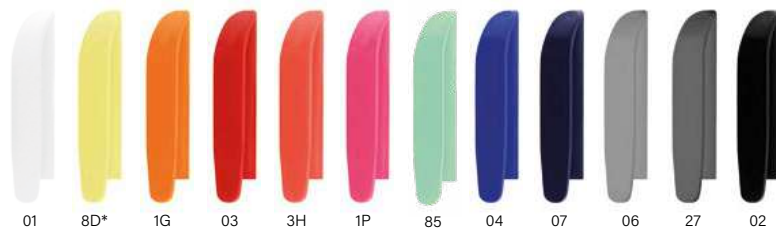

01 8D* 1G 03 3H 1P 85 04 07 06 27 02

Clear



51 87 93 88 86 89

Fusto



Opaco



01 03 1P 04 07 06 02

Sezione

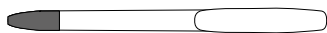

35

Esatta corrispondenza di colore: **≥ 10.000 pz.**



Personalizzazione

BIC® SUPER CLIP ADVANCE

1073

A SP: max. 2 col.

B SP: max. 1 col.

C DG: full-colour

D BP: full-colour

BP Texture: full-colour

MOQ 250 pz.

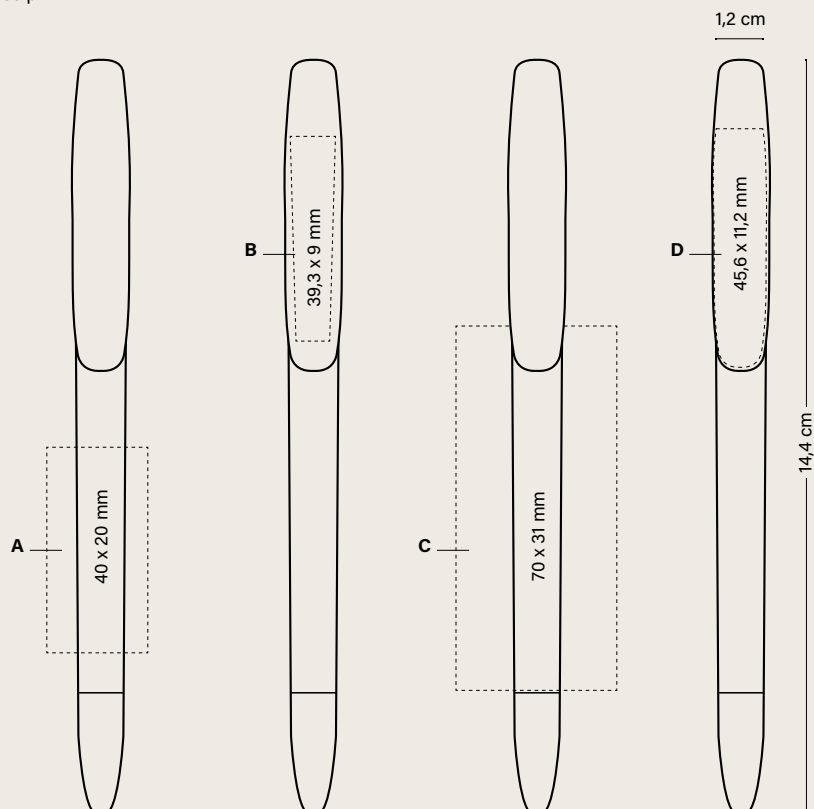

Prezzo (€)

BIC® SUPER CLIP ADVANCE	250-499	500-999	1000-2499	2500-4999	5000
1073					
SP	1,71	1,42	1,33	1,26	1,21
DG	2,09	1,71	1,61	1,51	1,47
BP	1,96	1,62	1,52	1,43	1,39

Costo di stampa aggiuntivo per colore e posizione

SP	0,17	0,14	0,14	0,14	0,13
BP	0,24	0,22	0,21	0,20	0,19
BP Texture	0,18	0,16	0,15	0,15	0,14

I prezzi includono una stampa in una posizione secondo la tecnica specificata.

CONFEZIONI SPECIALI OPZIONALI



ECO SLEEVE



PLASTIC POUCH



WINDOW BOX



COLLECTION BOX

Collection Box (1, 2 e 3 pz.)

+ INFO PAG. 240-245

IMBALLAGGIO ESTERNO



250 ± 2,6 KG

MIX & MATCH



COLORI PERSONALIZZATI



PRODOTTO E STAMPATO NEGLI STABILIMENTI BIC



PRODOTTO IN SPAGNA



CONFORMITÀ NORMATIVA



ISO certified



IMPRIM'VERT®



IL PROGRAMMA UBICUITY™ CONSENTE DI RICICLARE GLI STRUMENTI DI SCRITTURA BIC



100% DI ELETTRICITÀ PROVENIENTE DA FONTI RINNOVABILI

MODALITÀ DI SCRITTURA



PENNA A SFERA M Ø 1 MM

TECNICHE DI STAMPA



SERIGRAFIA



DIGITALE



BRITEPIX™
BRITEPIX™ TEXTURE
BRITEPIX™ PERSONALISATION

Vedere pagina 250 per una spiegazione dettagliata delle icone.

BIC® SUPER CLIP GLACÉ & ADVANCE

Scopri la BIC® Super Clip nella sua versione più glamour.

BIC® SUPER CLIP GLACÉ

1082

Colore inchiostro



47G

76

014G

03G

04G

05G

100%

BIC® SUPER CLIP GLACÉ ADVANCE

1084

Colore inchiostro



47G/35

05G/35

014G/35

03G/35

04G/35

76/35

100%



Servizio di
ricarica su
richiesta

BIC® SUPER CLIP GLACÉ & ADVANCE

Sezione

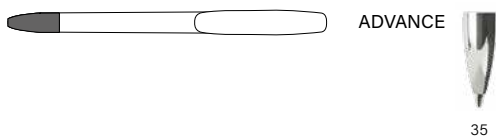

Personalizzazione

BIC® SUPER CLIP GLACÉ
1082

**BIC® SUPER CLIP GLACÉ
ADVANCE**
1084

A SP: max. 1 col.
B SP: max. 1 col.

MOQ 250 pz.
Combinazione colori standard

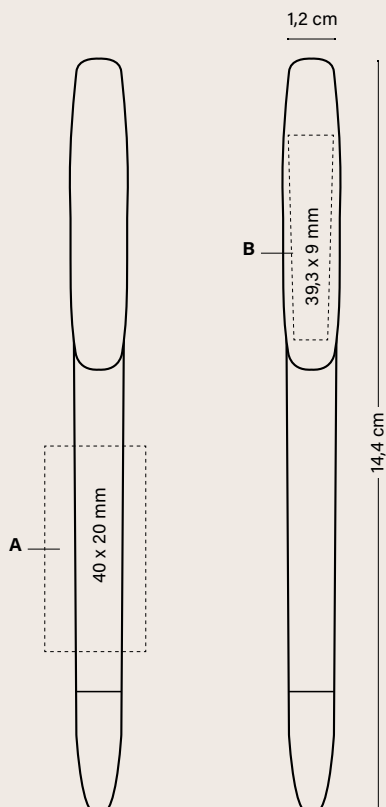

Prezzo (€)

BIC® SUPER CLIP GLACÉ	250-499	500-999	1000-2499	2500-4999	5000
1082					
SP	1,89	1,63	1,50	1,42	1,37
1084					
SP	2,31	1,90	1,75	1,65	1,60

Costo di stampa aggiuntivo per colore e posizione

SP	0,17	0,14	0,14	0,14	0,13
----	------	------	------	------	------

I prezzi includono una stampa in una posizione secondo la tecnica specificata.

CONFEZIONI SPECIALI OPZIONALI



+ INFO PAG. 240-245

IMBALLAGGIO ESTERNO



250 ± 2,6 KG

Collection Box
(1, 2 e 3 pz.)



IL PROGRAMMA UBICITY™
CONSENTE DI RICICLARE GLI
STRUMENTI DI SCRITTURA BIC



MODALITÀ DI SCRITTURA



TECNICHE DI STAMPA



GUARDA IL VIDEO

Vedere pagina 250 per una spiegazione dettagliata delle icone.

BIC® SUPER CLIP SOFT & ADVANCE

Apprezza l'incredibile
sensazione di setosità
della BIC® Super Clip.



BIC® SUPER CLIP SOFT

1083

Colore inchiostro



02F

03F

07F

100%

**BIC® SUPER CLIP SOFT
ADVANCE**

1085

Colore inchiostro



02F/35

03F/35

07F/35

100%



Servizio di ricarica
su richiesta

BIC® SUPER CLIP SOFT & ADVANCE

Sezione

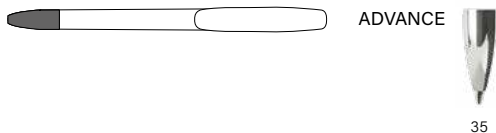

35

Personalizzazione

BIC® SUPER CLIP SOFT
1083

**BIC® SUPER CLIP SOFT
ADVANCE**
1085

A SP: max. 1 col.

MOQ 250 pz.
Combinazione colori standard

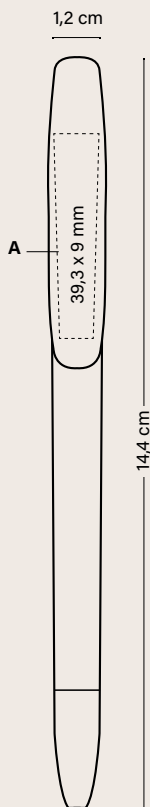

	Prezzo (€)				
	250-499	500-999	1000-2499	2500-4999	5000
BIC® SUPER CLIP SOFT					
1083					
SP	2,33	1,68	1,58	1,49	1,42
1085					
SP	2,89	2,30	2,16	2,08	1,94

Costo di stampa aggiuntivo per colore e posizione

SP	0,17	0,14	0,14	0,14	0,13
----	------	------	------	------	------

I prezzi includono una stampa in una posizione secondo la tecnica specificata.

CONFEZIONI SPECIALI OPZIONAL



ECO SLEEVE



PLASTIC POUCH



WINDOW BOX



COLLECTION BOX

Collection Box
(1, 2 e 3 pz.)



250 ± 2,6 KG

+ INFO PAG. 240-245



PRODOTTI E STAMPATI
NEGLI STABILIMENTI BIC



PRODOTTO IN SPAGNA



CONFORMITÀ
NORMATIVA



ISO
certified



IMPRIM'VERT®



IL PROGRAMMA UBIQUITY™
CONSENTE DI RICICLARE GLI
STRUMENTI DI SCRITTURA BIC



100% DI ELETTRICITÀ
PROVENIENTE DA FONTI
RINNOVABILI

MODALITÀ DI SCRITTURA



PENNA A SFERA M
Ø 1 MM

TECNICHE DI STAMPA



SERIGRAFIA



GUARDA IL VIDEO

Vedere pagina 250 per una spiegazione dettagliata delle icone.

BIC® SUPER CLIP ORIGIN

La nuova BIC® Super Clip
è realizzata a partire
da ingredienti naturali*.

ecolutions® REALIZZATA CON MATERIALE
DI ORIGINE BIOLOGICA.

BIC® SUPER CLIP ORIGIN

1038

Colore inchiostro



ORIGIN
BIOBASED

BIC® Super Clip Origin
è realizzata in materiale
biobased prodotto con
ingredienti naturali,
nessuno dei quali deriva
da petrolio o combustibili
fossili*.



Realizzata con olio di ricino e altri
ingredienti di origine vegetale.*

*Grazie all'uso di materiali naturali, le
nostre penne presentano variazioni
di colore uniche, che evidenziano la
natura autentica e caratteristica di
ogni pezzo.
Abbraccia il fascino della natura!*



Prodotto e stampato in
stabilimenti alimentati al **100%**
da energia elettrica rinnovabile.



Il fusto e la clip sono
al **100%** di origine
biologica.



Il programma **Ubiunity**, sviluppato da BIC in collaborazione con
Terracycle, consente di **riciclare le penne a sfera di BIC.**

NUOVO!



60

70

600

BIC® SUPER CLIP ORIGIN

Personalizzazione

BIC® SUPER CLIP ORIGIN

1038

A SP: max. 1 col.

MOQ 250 pz.
Combinazione colori standard

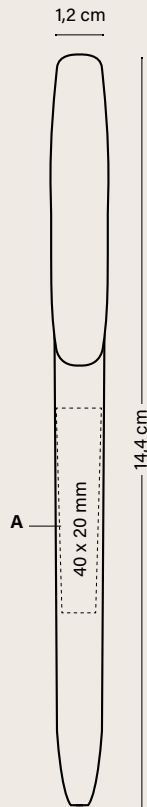

Prezzo (€)

BIC® SUPER CLIP ORIGIN	250-499	500-999	1000-2499	2500-4999	5000
1038					
SP	1,80	1,72	1,46	1,29	1,21

I prezzi includono serigrafia ad un colore in una posizione.

CONFEZIONI SPECIALI OPZIONALI



ECO SLEEVE

+ INFO PAG. 240-245



PLASTIC POUCH



WINDOW BOX



COLLECTION BOX

Collection Box
(1, 2 e 3 pz.)

Può essere
utilizzata come
segnalibro

IMBALLAGGIO ESTERNO



250 ± 2,6 KG



COLORI
PERSONALIZZATI



PRODOTTO E STAMPATO
NEGLI STABILIMENTI BIC



PRODOTTO IN SPAGNA



CONFORMITÀ
NORMATIVA



ISO
certified



IMPRIM'VERT®

ORIGIN
BIOBASED



IL PROGRAMMA UBICIVITY™
CONSENTE DI RICICLARE GLI
STRUMENTI DI SCRITTURA BIC



100% DI ELETTRICITÀ
PROVENIENTE DA FONTI
RINNOVABILI

TECNICHE
DI STAMPA



SP
SERIGRAFIA

Vedere pagina 250 per una spiegazione dettagliata delle icone.

BIC® WIDE BODY™

La giusta misura per mostrare il vero valore del tuo marchio!

Ampio profilo e vasta gamma di
possibilità per ottimizzare il tuo
messaggio.





L' iconico BIC® Boy è inciso!

BIC® WIDE BODY™

1079 Opaco Chrome

1080 Opaco

Colore inchiostro



Inchiostro rosso disponibile su richiesta



07

01

07

02

18



Stampa a 360°

100%

Disponibile in fusto bianco



BIC® WIDE BODY™

ecolutions® 1E80 Opaco

Colore inchiostro



Inchiostro rosso disponibile su richiesta



Stampa a 360°

100%

Disponibile in fusto bianco



Versione ECO. Allo stesso prezzo della versione standard!

ecolutions®



REALIZZATA CON IL 94% DI MATERIALE RICICLATO*



VASSOI DI FRUTTA E VERDURA

MIX & MATCH



COLORI PERSONALIZZATI



PRODOTTO E STAMPATO NEGLI STABILIMENTI BIC



PRODOTTO IN SPAGNA



CONFORMITÀ NORMATIVA



IMPRIM'VERT®

ecolutions®



VASSOI DI FRUTTA E VERDURA



IL PROGRAMMA UBICITY™ CONSENTE DI RICICLARE GLI STRUMENTI DI SCRITTURA BIC



100% DI ELETTRICITÀ PROVENIENTE DA FONTI RINNOVABILI

MODALITÀ DI SCRITTURA



PENNA A SFERA M Ø 1 MM

TECNICHE DI STAMPA



SERIGRAFIA



DIGITALE

*La percentuale è calcolata sul peso totale del prodotto refill escluso. A causa del contenuto riciclato delle materie prime con cui è realizzato il prodotto, non siamo in grado di garantire che i colori che appaiono in catalogo, né quelli personalizzati su richiesta, abbiano sempre lo stesso colore e aspetto.

BIC® WIDE BODY™

1080 Frosted
 Colore inchiostro
 ● ● ●



La nostra
 area di
 stampa più
 grande

BIC® WIDE BODY™

MINI DIGITAL
 1893 Opaco
 1896 Chrome Opaco
 Colore inchiostro
 ● ● ●



Stampa a 360°

Disponibile
 in fusto bianco



BIC® WIDE BODY™

1080 Opaco
ecolutions® 1E80 Opaco
1080 Frosted

BIC® WIDE BODY™ MINI DIGITAL

1893 Opaco
1896 Chrome Opaco

MOQ 250 pz.
Combinazione colori standard

MIX & MATCH

Nessun costo aggiuntivo

Tappino



Opaco



Frosted



Chrome



Clip



Opaco

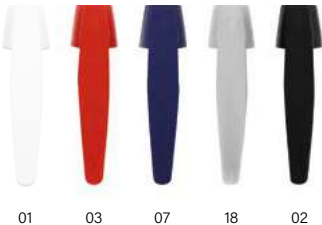

Frosted

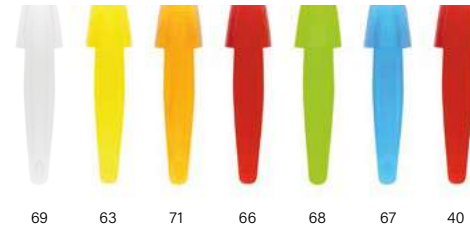

Fusto



Opaco



Frosted

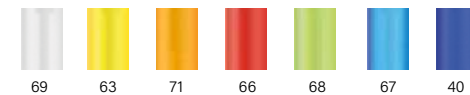

Opaco



ecolutions® **



Aggiungi il Mobius loop alla tua grafica senza costi aggiuntivi. Si prega di specificarlo nell'ordine. La stampa del Mobius loop viene fatta di default nell'angolo a sinistra.



VASSOI DI FRUTTA E VERDURA

Sezione

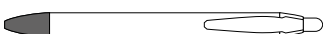

Opaco

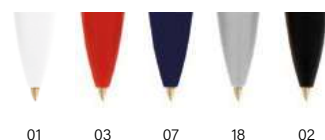

Frosted



Chrome



Esatta corrispondenza di colore: **≥ 10.000 pz.**



MIX & MATCH



COLORI PERSONALIZZATI



PRODOTTO E STAMPATO NEGLI STABILIMENTI BIC



PRODOTTO IN SPAGNA



CONFORMITÀ NORMATIVA



IMPRIM'VERT®

ecolutions®



VASSOI DI FRUTTA E VERDURA



IL PROGRAMMA UBICITY™ CONSENTE DI RICICLARE GLI STRUMENTI DI SCRITTURA BIC



100% DI ELETTRICITÀ PROVENIENTE DA FONTI RINNOVABILI

MODALITÀ DI SCRITTURA



PENNA A SFERA M Ø 1 MM

TECNICHE DI STAMPA



SP SERIGRAFIA



DG DIGITALE

*Fino ad esaurimento scorte

** A causa del contenuto riciclato delle materie prime con cui è realizzato il prodotto, non siamo in grado di garantire che i colori che appaiono in catalogo, né quelli personalizzati su richiesta, abbiano sempre lo stesso colore e aspetto.

BIC® WIDE BODY™

BIC® WIDE BODY™

1080 Opaco
1079 Opaco Chrome
eColutions® 1E80

A/C SP: max. 2 col.

B/F SP: max. 1 col.

D DG: full-colour (area per le immagini)

E DG: full-colour (area per il testo)

MOQ 250 pz. (SP)

MOQ 500 pz. (DG)

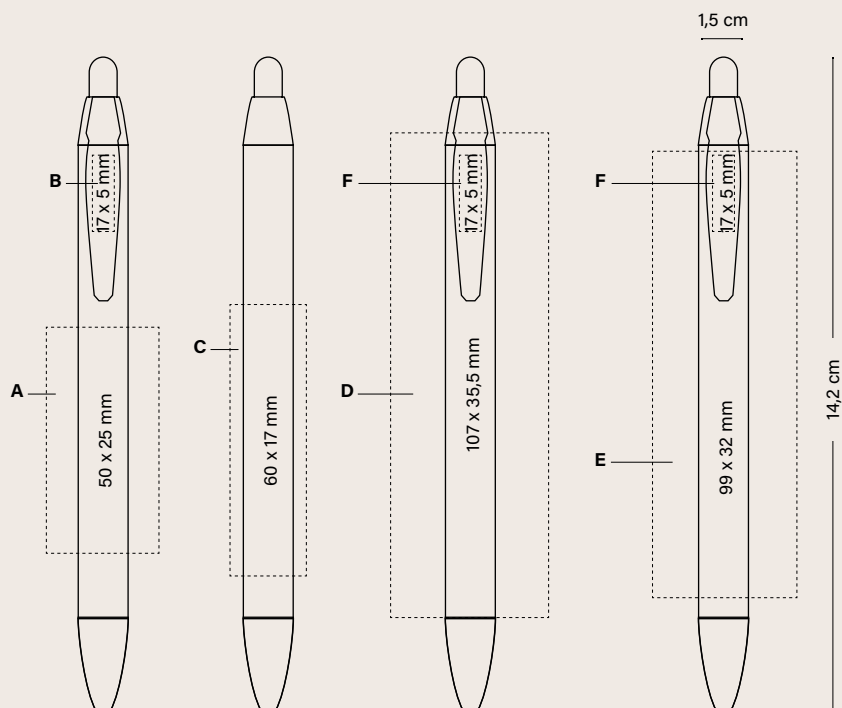

	Prezzo (€)				
BIC® WIDE BODY™	250-499	500-999	1000-2499	2500-4999	5000
1080 / eColutions® 1E80					
SP	1,38	1,02	0,96	0,90	0,82
DG	-	1,42	1,32	1,23	1,15
1079					
SP	2,39	1,94	1,79	1,70	1,56
DG	-	2,32	2,16	2,05	1,91

Costo di stampa aggiuntivo per colore e posizione

SP	0,17	0,14	0,14	0,14	0,13
----	------	------	------	------	------

I prezzi includono una stampa in una posizione secondo la tecnica specificata.

CONFEZIONI SPECIALI OPZIONAL



ECO SLEEVE



PLASTIC POUCH



WINDOW BOX



COLLECTION BOX

Collection Box
(1, 2 e 3 pz.)

IMBALLAGGIO ESTERNO



250 ± 2,6KG

+ INFO PAG. 240-245

**BIC® WIDE BODY™
MINI DIGITAL**

1893

**BIC® WIDE BODY™
MINI CHROME DIGITAL**

1896

A DG: full-colour (area per le immagini)

B DG: full-colour (area per il testo)

MOQ 500 pz. (DG)

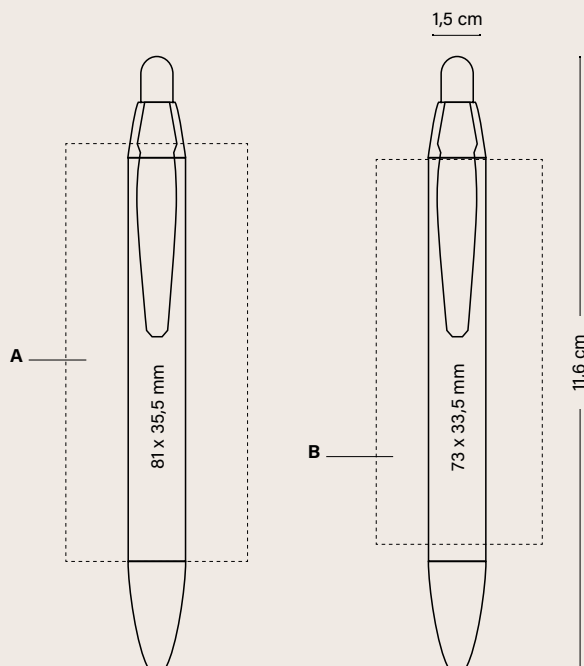

	Prezzo (€)			
BIC® WIDE BODY™ MINI DIGITAL	500-999	1000-2499	2500-4999	5000
1893				
DG	1,25	1,16	1,09	1,03
1896				
DG	2,16	2,02	1,92	1,76

I prezzi includono stampa digitale sul corpo.

CONFEZIONI SPECIALI OPZIONAL



ECO SLEEVE



PLASTIC POUCH



WINDOW BOX



COLLECTION BOX

IMBALLAGGIO ESTERNO



250 ± 2,6KG

Collection Box
(1, 2 e 3 pz.)

+ INFO PAG. 240-245



COLORI
PERSONALIZZATI



PRODOTTO E STAMPATO
NEGLI STABILIMENTI BIC



PRODOTTO IN SPAGNA



CONFORMITÀ
NORMATIVA



IMPRIM'VERT®
eColutions®



VASSOI DI
FRUTTA E
VERDURA



IL PROGRAMMA U'BICIVITY™
CONSENTE DI RICICLARE GLI
STRUMENTI DI SCRITTURA BIC



100% DI ELETTRICITÀ
PROVENIENTE DA FONTI
RINNOVABILI

**MODALITÀ
DI SCRITTURA**



PENNA A SFERA M
Ø 1 MM

**TECNICHE
DI STAMPA**



SERIGRAFIA



DIGITALE

Vedere pagina 250 per una spiegazione dettagliata delle icone.





BIC® 4 COLOURS®

Conosciuta in tutto il mondo, la penna a sfera BIC® 4 Colours® ti offre la comodità di quattro diversi colori di inchiostro in un'unica penna, rendendola un'ottima scelta per prendere appunti o registrare dati in diversi colori. Questa penna versatile ha una punta media di 1,0 mm e contiene inchiostro a lunga durata. Per una maggiore comodità, è dotata di un foro per un laccetto, così da portarla con te ovunque. Scopri tutte le diverse versioni: Classic, Fashion, Sun, Fine, Shine, Fluo, Stylus, 3+1^{HB} (con portamine) Glacé, Soft, Wood Style e le ultimi versioni Pastel, Bicolor, Gradient e Flags Collection.

BICOLOR
GRADIENT
PASTEL
FASHION
SUN
FINE
FLUO

SHINE
GLACÉ
SOFT
WOOD STYLE
FLAGS COLLECTION
3+1^{HB}



BIC® 4 COLOURS®

Sempre un'icona.



LA SOLUZIONE
DEFINITIVA PER
LA COMUNICAZIONE
FULL COLOUR!

*Ora sui nuovi
fusti colorati*

BIC® 4 COLOURS®

1100 Opaco
1101 Con Lanyard
Colore inchiostro



01/01

02/02

01/03

01/05

01/02

01/12

01/07

NUOVO!

Nuova area
di stampa

Stampa a 360°



Servizio di ricarica
su richiesta

Personalizzazione

BIC® 4 COLOURS®

1100/1101

A SP: max. 4 col.

B DG: Digital print (area per le immagini)

C BP: full-colour

D SP: 1 col. (Solo per le parti superiori bianche).

MOQ 250 pz. (SP, DG)

MOQ 100 pz. (BP)

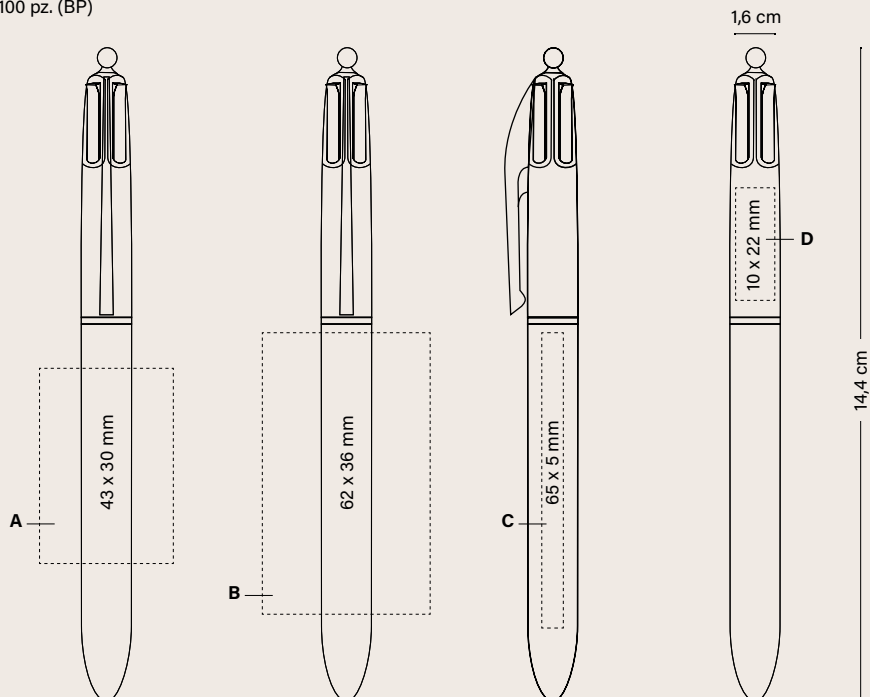

BIC® 4 COLOURS®	Prezzo (€)					
	100-249	250-499	500-999	1000-2499	2500-4999	5000
1100						
SP	-	3,51	3,18	2,94	2,75	2,59
DG	-	4,80	4,35	4,04	3,75	3,54
BP	4,65	3,79	3,43	3,19	2,99	2,81
1101 (Lanyard)						
SP	-	3,68	3,61	3,24	3,14	2,94
DG	-	5,26	4,78	4,42	4,12	3,90
BP	5,21	4,26	3,86	3,58	3,37	3,17

Costo di stampa aggiuntivo per colore e posizione

SP	-	0,17	0,14	0,14	0,14	0,13
BP	0,26	0,24	0,22	0,21	0,20	0,19
BP Texture	0,20	0,18	0,16	0,15	0,15	0,14

I prezzi includono una stampa in una posizione secondo la tecnica specificata.

Parte bianca superiore, 1 colore	-	0,17	0,14	0,14	0,14	0,13
----------------------------------	---	------	------	------	------	------

CONFEZIONI SPECIALI OPZIONAL



ECO SLEEVE



PLASTIC POUCH



WINDOW BOX



COLLECTION BOX



250 ± 3,2KG

Collection Box (1, 2 e 3 pz.)

+ INFO PAG. 240-245

IMBALLAGGIO ESTERNO



COLORI PERSONALIZZATI



PRODOTTO E STAMPATO NEGLI STABILIMENTI BIC



PRODOTTO IN FRANCIA



CONFORMITÀ NORMATIVA



ISO certified



IMPRIM'VERT®



IL PROGRAMMA UBICITY™ CONSENTE DI RICICLARE GLI STRUMENTI DI SCRITTURA BIC



100% DI ELETTRICITÀ PROVENIENTE DA FONTI RINNOVABILI

MODALITÀ DI SCRITTURA



PENNA A SFERA M Ø 1 MM

TECNICHE DI STAMPA



SERIGRAFIA



DIGITALE



BRITEPIX™

BIC® 4 COLOURS® BICOLOR Look metallico con un tocco artistico.

BIC® 4 COLOURS® BICOLOR

1069 Opaco
1076 Con Lanyard
Colore inchiostro



01/04G/47



01/05G/47



01/80/47



01/4R/47

NUOVO!

Nuova area
di stampa



Servizio di ricarica
su richiesta

Personalizzazione

BIC® 4 COLOURS® BICOLOR

1069/1076

A SP: max. 2 col.

B SP: max. 1 col.

MOQ 250 pz.

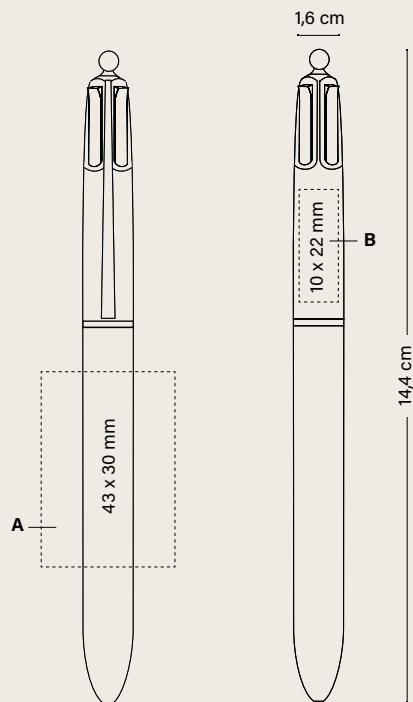

	Prezzo (€)					
BIC® 4 COLOURS® BICOLOR	100-249	250-499	500-999	1000-2499	2500-4999	5000
1069						
SP	-	5,41	4,91	4,51	4,24	3,99
1076						
SP	-	4,91	4,46	4,11	3,85	3,62

Costo di stampa aggiuntivo per colore e posizione

SP	-	0,17	0,14	0,14	0,14	0,13
Parte bianca superiore, 1 colore	-	0,17	0,14	0,14	0,14	0,13

I prezzi includono una stampa in una posizione secondo la tecnica specificata.

CONFEZIONI SPECIALI OPZIONAL



+ INFO PAG. 240-245

IMBALLAGGIO ESTERNO



250 ± 3,2KG

Collection Box
(1, 2 e 3 pz.)



COLORI PERSONALIZZATI



PRODOTTO E STAMPATO NEGLI STABILIMENTI BIC



PRODOTTO IN FRANCIA



CONFORMITÀ NORMATIVA



IMPRIM'VERT®



IL PROGRAMMA UBICIVITY™ CONSENTE DI RICICLARE GLI STRUMENTI DI SCRITTURA BIC



100% DI ELETTRICITÀ PROVENIENTE DA FONTI RINNOVABILI

MODALITÀ DI SCRITTURA



PENNA A SFERA M Ø 1 MM

TECNICHE DI STAMPA



SERIGRAFIA

BIC® 4 COLOURS® GRADIENT

Un'esplosione di colori estivi.

BIC® 4 COLOURS® GRADIENT

1074 Opaco
1075 Con Lanyard
Colore inchiostro



NUOVO!

Nuova area di stampa



Servizio di ricarica su richiesta

01/3G/8D/4R

Personalizzazione

BIC® 4 COLOURS® GRADIENT

1074/1075

A SP: max. 2 col.

B SP: max. 1 col.

MOQ 250 pz.

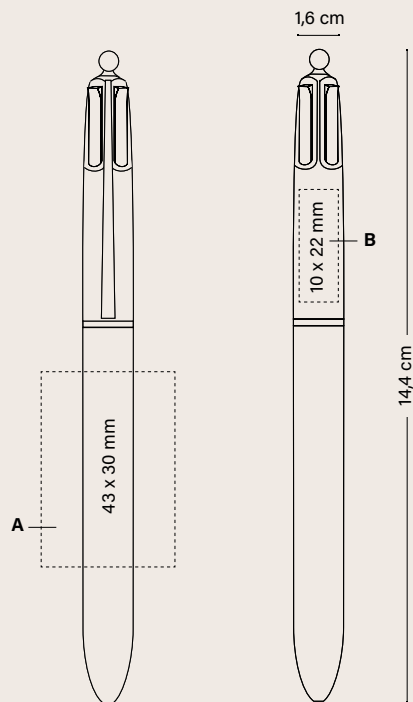

	Prezzo (€)					
BIC® 4 COLOURS® GRADIENT	100-249	250-499	500-999	1000-2499	2500-4999	5000
1074						
SP	-	4,91	4,46	4,11	3,85	3,62
1075						
SP	-	5,41	4,91	4,51	4,24	3,99
Costo di stampa aggiuntivo per colore e posizione						
SP	-	0,17	0,14	0,14	0,14	0,13
Parte bianca superiore, 1 colore	-	0,17	0,14	0,14	0,14	0,13

I prezzi includono una stampa in una posizione secondo la tecnica specificata.

CONFEZIONI SPECIALI OPZIONAL



+ INFO PAG. 240-245

IMBALLAGGIO ESTERNO



250 ± 3,2KG

Collection Box
(1, 2 e 3 pz.)



COLORI
PERSONALIZZATI



PRODOTTO E STAMPATO
NEGLI STABILIMENTI BIC



PRODOTTO IN FRANCIA



CONFORMITÀ
NORMATIVA



IMPRIM'VERT®



IL PROGRAMMA URICITY™
CONSENTE DI RICICLARE GLI
STRUMENTI DI SCRITTURA BIC



100% DI ELETTRICITÀ
PROVENIENTE DA FONTI
RINNOVABILI

MODALITÀ
DI SCRITTURA



PENNA A SFERA M
Ø 1 MM

TECNICHE
DI STAMPA



SERIGRAFIA

BIC® 4 COLOURS®

**Colori vintage,
immagini da sogno.**

NUOVO!

BIC® 4 COLOURS® PASTEL

1071 Opaco
1072 Con Lanyard
Colore inchiostro



84

8D



Servizio di ricarica
su richiesta

83

Personalizzazione

BIC® 4 COLOURS® PASTEL

1071/1072

A SP: max. 4 col.

MOQ 250 pz.

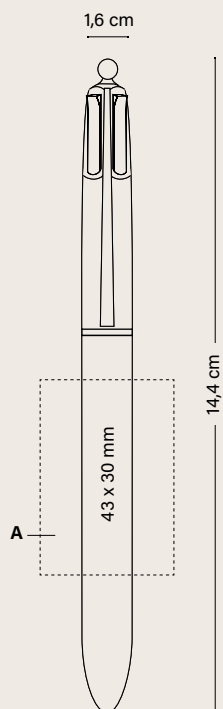

Prezzo (€)

BIC® 4 COLOURS® PASTEL	100-249	250-499	500-999	1000-2499	2500-4999	5000
1071						
SP	-	3,51	3,18	2,94	2,75	2,59
1072						
SP	-	3,98	3,61	3,34	3,14	2,94
Costo di stampa aggiuntivo per colore e posizione						
SP	-	0,17	0,14	0,14	0,14	0,13

I prezzi includono una stampa in una posizione secondo la tecnica specificata.

CONFEZIONI SPECIALI OPZIONAL



ECO SLEEVE



PLASTIC POUCH



WINDOW BOX



COLLECTION BOX



250 ± 3,2KG

Collection Box
(1, 2 e 3 pz.)

+ INFO PAG. 240-245

IMBALLAGGIO ESTERNO



COLORI PERSONALIZZATI



PRODOTTO E STAMPATO NEGLI STABILIMENTI BIC



PRODOTTO IN FRANCIA



CONFORMITÀ NORMATIVA



ISO certified



IMPRIM'VERT®



IL PROGRAMMA UBI-CITY™ CONSENTE DI RICICLARE GLI STRUMENTI DI SCRITTURA BIC



100% DI ELETTRICITÀ PROVENIENTE DA FONTI RINNOVABILI

MODALITÀ DI SCRITTURA



PENNA A SFERA M Ø 1 MM

TECNICHE DI STAMPA



SERIGRAFIA



LA SOLUZIONE
DEFINITIVA PER
LA COMUNICAZIONE
FULL COLOUR!

*Ora sui nuovi
corpi colorati*

4 COLOURS® FASHION

1102 Opaco
1108 Con Lanyard
Colore inchiostro
●●●●



←
Colori fashion!

Nuova area
di stampa

→ Stampa a 360°



Servizio di ricarica
su richiesta

100%

01/01

01/84

01/24

Personalizzazione

BIC® 4 COLOURS® FASHION
1102/1108

A SP: max. 4 col.
B DG: Digital print (area per le immagini)
C BP: full-colour
D SP: max. 1 col.

MOQ 250 pz. (SP, DG)
MOQ 100 pz. (BP)

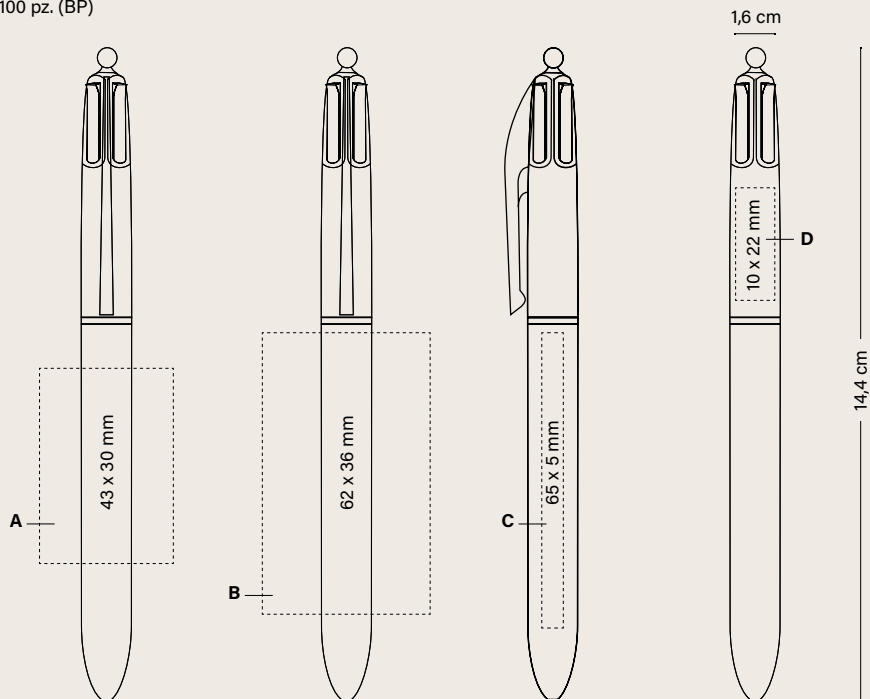

Prezzo (€)

BIC® 4 COLOURS® FASHION 100-249 250-499 500-999 1000-2499 2500-4999 5000

1102

SP	-	3,51	3,18	2,94	2,75	2,59
DG	-	4,80	4,35	4,04	3,75	3,54
BP	4,65	3,79	3,43	3,19	2,99	2,81

1108 (Lanyard)

SP	-	3,98	3,61	3,34	3,14	2,94
DG	-	5,26	4,78	4,42	4,12	3,90
BP	5,21	4,26	3,86	3,58	3,37	3,17

Costo di stampa aggiuntivo per colore e posizione

SP	-	0,17	0,14	0,14	0,14	0,13
BP	0,26	0,24	0,22	0,21	0,20	0,19
BP Texture	0,20	0,18	0,16	0,15	0,15	0,14

I prezzi includono una stampa in una posizione secondo la tecnica specificata.

Parte bianca superiore, 1 colore	-	0,17	0,14	0,14	0,14	0,13
---	---	------	------	------	------	------

CONFEZIONI SPECIALI OPZIONAL



+ INFO PAG. 240-245

IMBALLAGGIO ESTERNO



Collection Box
(1, 2 e 3 pz.)



COLORI PERSONALIZZATI



PRODOTTO E STAMPATO NEGLI STABILIMENTI BIC



PRODOTTO IN FRANCIA



CONFORMITÀ NORMATIVA



ISO certified



IMPRIM'VERT®



IL PROGRAMMA UBICUITY™ CONSENTE DI RICICLARE GLI STRUMENTI DI SCRITTURA BIC



100% DI ELETTRICITÀ PROVENIENTE DA FONTI RINNOVABILI

MODALITÀ DI SCRITTURA



PENNA A SFERA M 0,1 MM

TECNICHE DI STAMPA



SERIGRAFIA



BRITEPIX™
BRITEPIX™ TEXTURE
BRITEPIX™ PERSONALISATION

Vedere pagina 250 per una spiegazione dettagliata delle icone.



LA SOLUZIONE
DEFINITIVA PER
LA COMUNICAZIONE
FULL COLOUR!

BIC® 4 COLOURS® SUN

1097 Opaco
1098 Con Lanyard
Colore inchiostro
●●●●



01/12

01/12

Personalizzazione

BIC® 4 COLOURS® SUN

1097/1098

A SP: max. 4 col.

B DG: Digital print (area per le immagini)

C BP: full-colour

D SP: max. 1 col.

MOQ 250 pz. (SP, DG)

MOQ 100 pz. (BP)

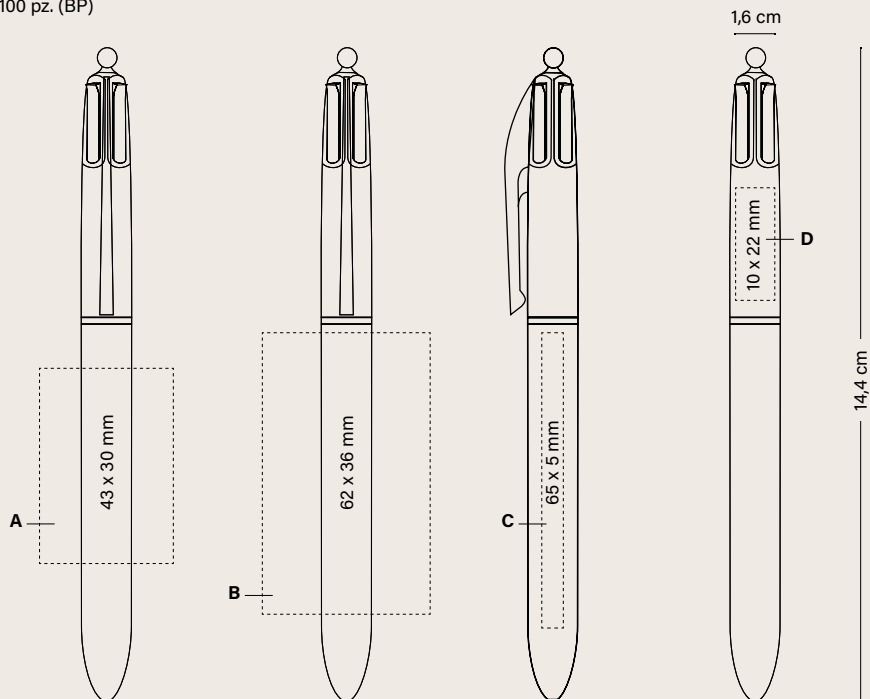

	Prezzo (€)					
BIC® 4 COLOURS® SUN	100-249	250-499	500-999	1000-2499	2500-4999	5000
1097						
SP	-	3,51	3,18	2,94	2,75	2,59
DG	-	4,80	4,35	4,04	3,75	3,54
BP	4,65	3,79	3,43	3,19	2,99	2,81
1098 (Lanyard)						
SP	-	3,98	3,61	3,34	3,14	2,94
DG	-	5,26	4,78	4,42	4,12	3,90
BP	5,21	4,26	3,86	3,58	3,37	3,17

Costo di stampa aggiuntivo per colore e posizione

SP	-	0,17	0,14	0,14	0,14	0,13
BP	0,26	0,24	0,22	0,21	0,20	0,19
BP Texture	0,20	0,18	0,16	0,15	0,15	0,14

I prezzi includono una stampa in una posizione secondo la tecnica specificata.

Parte bianca superiore, 1 colore	-	0,17	0,14	0,14	0,14	0,13
----------------------------------	---	------	------	------	------	------

CONFEZIONI SPECIALI OPZIONAL



ECO SLEEVE



PLASTIC POUCH



WINDOW BOX



COLLECTION BOX



Collection Box (1, 2 e 3 pz.)

250 ± 3,2KG

+ INFO PAG. 240-245

IMBALLAGGIO ESTERNO



COLORI PERSONALIZZATI



PRODOTTO E STAMPATO NEGLI STABILIMENTI BIC



PRODOTTO IN FRANCIA



CONFORMITÀ NORMATIVA



ISO certified



IMPRIM'VERT®



IL PROGRAMMA UBICUTY™ CONSENTE DI RICICLARE GLI STRUMENTI DI SCRITTURA BIC



100% DI ELETTRICITÀ PROVENIENTE DA FONTI RINNOVABILI



MODALITÀ DI SCRITTURA



PENNA A SFERA M 01 MM



TECNICHE DI STAMPA



SP SERIGRAFIA



DG DIGITALE



BRITEPIX™ BRITEPIX™ TEXTURE BRITEPIX™ PERSONALISATION

Vedere pagina 250 per una spiegazione dettagliata delle icone.



LA SOLUZIONE
DEFINITIVA PER
LA COMUNICAZIONE
FULL COLOUR!

BIC® 4 COLOURS® FINE

- 1109 Opaco
- 1111 Con Lanyard
- Colore inchiostro



Nuova area
di stampa



Servizio di
ricarica su
richiesta

100%

01/10

01/10

0.8mm
punta

Personalizzazione

BIC® 4 COLOURS® FINE

1109/1111

- A SP:** max. 4 col.
- B DG:** Digital print
- C BP:** full-colour
- D SP:** max. 1 col.

MOQ 250 pz. (SP, DG)

MOQ 100 pz. (BP)

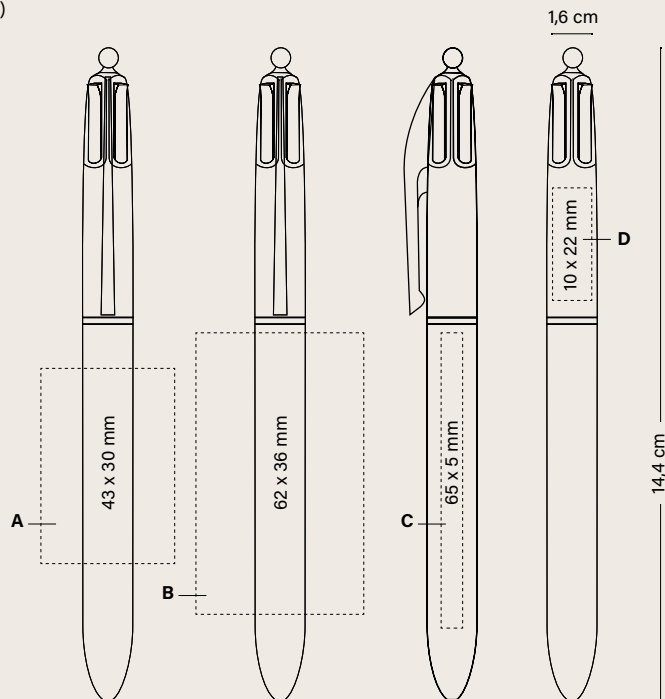

Prezzo (€)

BIC® 4 COLOURS® FINE

	100-249	250-499	500-999	1000-2499	2500-4999	5000
1109						
SP	-	3,51	3,18	2,94	2,75	2,59
DG	-	4,80	4,35	4,04	3,75	3,54
BP	4,65	3,79	3,43	3,19	2,99	2,81

1111 (Lanyard)

SP	-	3,98	3,61	3,34	3,14	2,94
DG	-	5,26	4,78	4,42	4,12	3,90
BP	5,21	4,26	3,86	3,58	3,37	3,17

Costo di stampa aggiuntivo per colore e posizione

SP	-	0,17	0,14	0,14	0,14	0,13
BP	0,26	0,24	0,22	0,21	0,20	0,19
BP Texture	0,20	0,18	0,16	0,15	0,15	0,14

I prezzi includono una stampa in una posizione secondo la tecnica specificata.

Parte bianca superiore, 1 colore						
	-	0,17	0,14	0,14	0,14	0,13

CONFEZIONI SPECIALI OPZIONAL



+ INFO PAG. 240-245

IMBALLAGGIO ESTERNO



Collection Box (1, 2 e 3 pz.)



COLORI PERSONALIZZATI



PRODOTTO E STAMPATO NEGLI STABILIMENTI BIC



PRODOTTO IN FRANCIA



CONFORMITÀ NORMATIVA



ISO certified



IMPRIM'VeRT®



IL PROGRAMMA URICITY™ CONSENTE DI RICICLARE GLI STRUMENTI DI SCRITTURA BIC



100% DI ELETTRICITÀ PROVENIENTE DA FONTI RINNOVABILI

MODALITÀ DI SCRITTURA



PENNA A SFERA M Ø 0,8 MM

TECNICHE DI STAMPA



SERIGRAFIA



DIGITALE



BRITEPIX™

BRITEPIX™ TEXTURE
BRITEPIX™
PERSONALISATION

Vedere pagina 250 per una spiegazione dettagliata delle icone.

BIC® 4 COLOURS® FLUO

1114 Opaco
1116 Con Lanyard
Colore inchiostro
●●●●



01/4D



01/4D

100%

4 colori di inchiostro, di cui uno è giallo fluo!

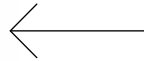

Nuova area di stampa



Servizio di ricarica su richiesta

Personalizzazione

BIC® 4 COLOURS® FLUO

1114/1116

A SP: max. 4 col.

B BP: full-colour

C SP: max. 1 col.

MOQ 250 pz. (SP, DG)

MOQ 100 pz. (BP)

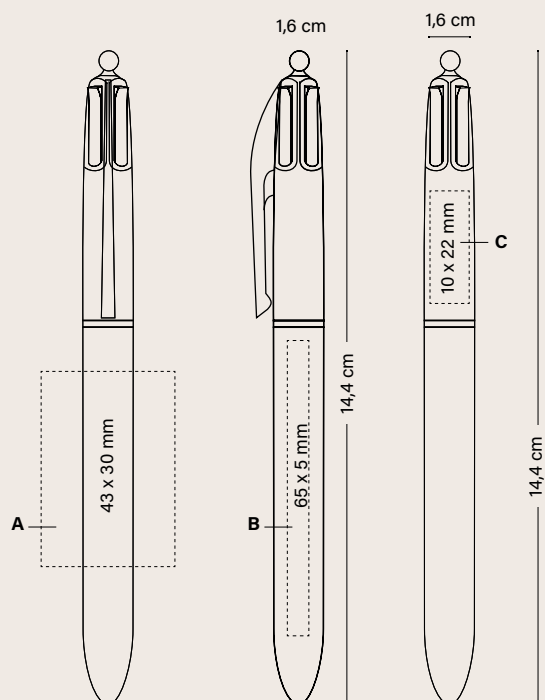

Prezzo (€)

BIC® 4 COLOURS® FLUO

	100-249	250-499	500-999	1000-2499	2500-4999	5000
1114						
SP	-	3,80	3,43	3,18	2,98	2,81
BP	4,65	4,08	3,69	3,42	3,20	3,03

1116 (Lanyard)

	100-249	250-499	500-999	1000-2499	2500-4999	5000
SP	-	4,31	3,89	3,59	3,38	3,19
BP	5,56	4,58	4,14	3,83	3,61	3,41

Costo di stampa aggiuntivo per colore e posizione

	100-249	250-499	500-999	1000-2499	2500-4999	5000
SP	-	0,17	0,14	0,14	0,14	0,13
BP	0,26	0,24	0,22	0,21	0,20	0,19
BP Texture	0,20	0,18	0,16	0,15	0,15	0,14

I prezzi includono una stampa in una posizione secondo la tecnica specificata.

	100-249	250-499	500-999	1000-2499	2500-4999	5000
Parte bianca superiore, 1 colore	-	0,17	0,14	0,14	0,14	0,13

CONFEZIONI SPECIALI OPZIONAL



ECO SLEEVE



PLASTIC POUCH



WINDOW BOX



Collection Box
(1, 2 e 3 pz.)



250 ± 3,2KG

+ INFO PAG. 240-245

IMBALLAGGIO ESTERNO



COLORI PERSONALIZZATI



PRODOTTO E STAMPATO NEGLI STABILIMENTI BIC



PRODOTTO IN FRANCIA



CONFORMITÀ NORMATIVA



ISO certified



IMPRIM'VERT®



IL PROGRAMMA UBICITY™ CONSENTE DI RICICLARE GLI STRUMENTI DI SCRITTURA BIC



100% DI ELETTRICITÀ PROVENIENTE DA FONTI RINNOVABILI

MODALITÀ DI SCRITTURA



PENNA A SFERA M Ø 1 MM

TECNICHE DI STAMPA



SERIGRAFIA



DIGITALE



BRITEPIX™
BRITEPIX™ TEXTURE
BRITEPIX™
PERSONALISATION

Vedere pagina 250 per una spiegazione dettagliata delle icone.

BIC® 4 COLOURS® SHINE

1106 Opaco

1107 Con Lanyard

Colore inchiostro



01/75

01/26

01/7G

01/34

01/97

Nuova area di stampa

Fusti super brillanti!



Servizio di ricarica su richiesta

BIC® 4 COLOURS® SHINE

Personalizzazione

BIC® 4 COLOURS® SHINE

1106/1107

A SP: max. 2 col.

B LE

C LE

D LE: 360°

E SP: max. 1 col.

MOQ 250 pz.

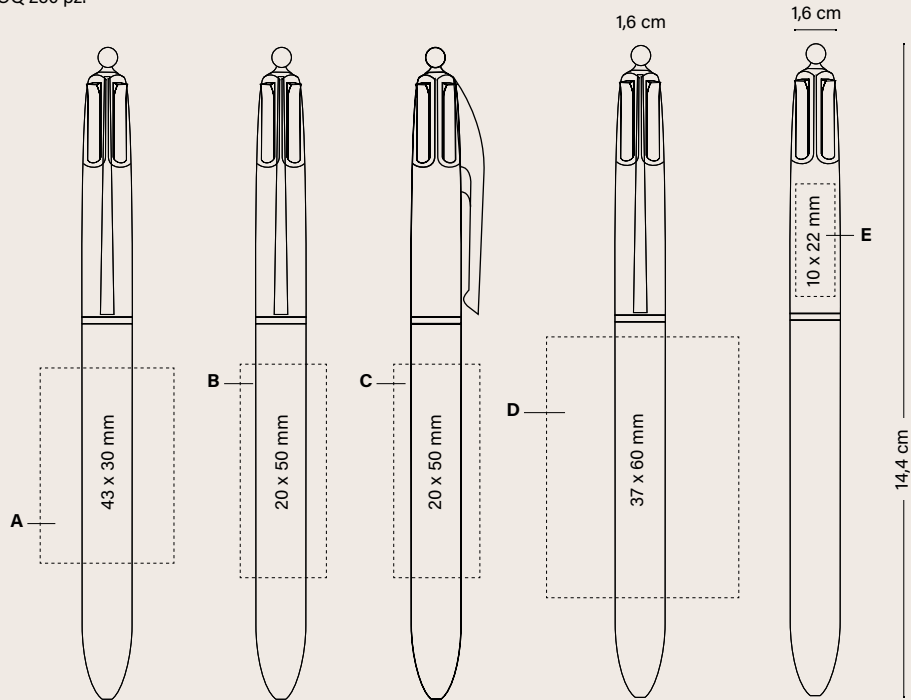

Prezzo (€)

BIC® 4 COLOURS® SHINE	250-499	500-999	1000-2499	2500-4999	5000
1106					
SP	4,02	3,62	3,37	3,15	2,94
LE	4,94	4,44	4,12	3,84	3,63
LE 360°	5,59	5,04	4,69	4,37	4,11
1107 (Lanyard)					
SP	4,51	4,07	3,77	3,54	3,31
LE	5,43	4,88	4,54	4,25	4,00
LE 360°	6,10	5,50	5,10	4,78	4,49

Costo di stampa aggiuntivo per colore e posizione

SP	0,17	0,14	0,14	0,14	0,13
----	------	------	------	------	------

I prezzi includono una stampa in una posizione secondo la tecnica specificata.

Parte bianca superiore, 1 colore	0,17	0,14	0,14	0,14	0,13
----------------------------------	------	------	------	------	------

CONFEZIONI SPECIALI OPZIONAL



+ INFO PAG. 240-245



PLASTIC POUCH



WINDOW BOX



COLLECTION BOX

Collection Box (1, 2 e 3 pz.)



250 ± 3,2KG

IMBALLAGGIO ESTERNO



COLORI PERSONALIZZATI



PRODOTTO E STAMPATO NEGLI STABILIMENTI BIC



PRODOTTO IN FRANCIA



CONFORMITÀ NORMATIVA



IMPRIM'VERT®



IL PROGRAMMA URICITY™ CONSENTE DI RICICLARE GLI STRUMENTI DI SCRITTURA BIC



100% DI ELETTRICITÀ PROVENIENTE DA FONTI RINNOVABILI

MODALITÀ DI SCRITTURA



PENNA A SFERA M Ø 1 MM

TECNICHE DI STAMPA



SERIGRAFIA



LASER

BIC® 4 COLOURS® GLACÉ

La nostra penna iconica in abito elegante

BIC® 4 COLOURS® GLACÉ

1057 Opaco
1058 Con Lanyard
Colore inchiostro



NUOVO!



01/76

01/47G

01/03G

01/05G

01/04G

02/47G

02/76

01/14G

Nuova area di stampa



Servizio di ricarica su richiesta

BIC® 4 COLOURS® GLACÉ

Personalizzazione

BIC® 4 COLOURS® GLACÉ

1057/1058

A SP: max. 2 col.

B SP: max. 1 col. (Solo per le parti superiori bianche)

MOQ 250 pz.

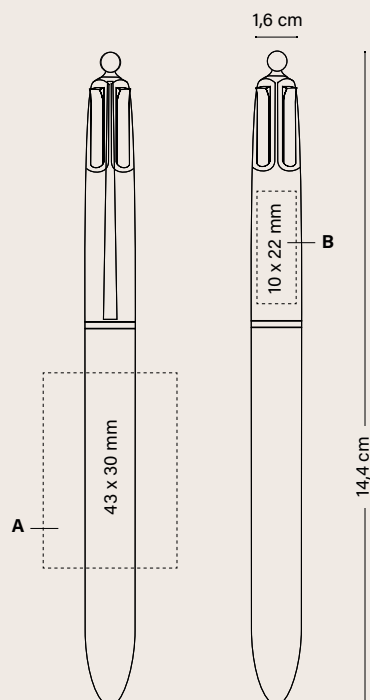

BIC® 4 COLOURS® GLACÉ	250-499	500-999	1000-2499	2500-4999	5000	Prezzo (€)
1057						
SP	4,02	3,62	3,37	3,15	2,94	
1058 (Lanyard)						
SP	4,49	4,05	3,75	3,52	3,29	
Costo di stampa aggiuntivo per colore e posizione						
SP	0,17	0,14	0,14	0,14	0,13	
I prezzi includono serigrafia ad un colore in una posizione.						
Parte bianca superiore, 1 colore	0,17	0,14	0,14	0,14	0,13	

CONFEZIONI SPECIALI OPZIONAL



ECO SLEEVE



PLASTIC POUCH



WINDOW BOX



COLLECTION BOX

Collection Box (1, 2 e 3 pz.)



250 ± 3,2KG

+ INFO PAG. 240-245

IMBALLAGGIO ESTERNO



COLORI PERSONALIZZATI



PRODOTTO E STAMPATO NEGLI STABILIMENTI BIC



PRODOTTO IN FRANCIA



CONFORMITÀ NORMATIVA



ISO certified



IMPRIM'VERT®



IL PROGRAMMA UBRICITY™ CONSENTE DI RICICLARE GLI STRUMENTI DI SCRITTURA BIC



100% DI ELETTRICITÀ PROVENIENTE DA FONTI RINNOVABILI



MODALITÀ DI SCRITTURA



PENNA A SFERA M Ø 1 MM



TECNICHE DI STAMPA



SERIGRAFIA

Vedere pagina 250 per una spiegazione dettagliata delle icone.

BIC® 4 COLOURS® SOFT

Una superficie morbida che non vorrai mai smettere di toccare!



BIC® 4 COLOURS® SOFT

1060 Opaco
1063 Con Lanyard
Colore inchiostro



NUOVO!



01/03F



01/02F



02/02F



01/07F

Nuova area
di stampa

Senti la
morbidezza nelle
tue mani



Servizio di ricarica
su richiesta

BIC® 4 COLOURS® SOFT

Personalizzazione

BIC® 4 COLOURS® SOFT

1060/1063

A SP: max. 1 col.

B SP: max. 1 col. (Solo per le parti superiori bianche)

MOQ 250 pz.

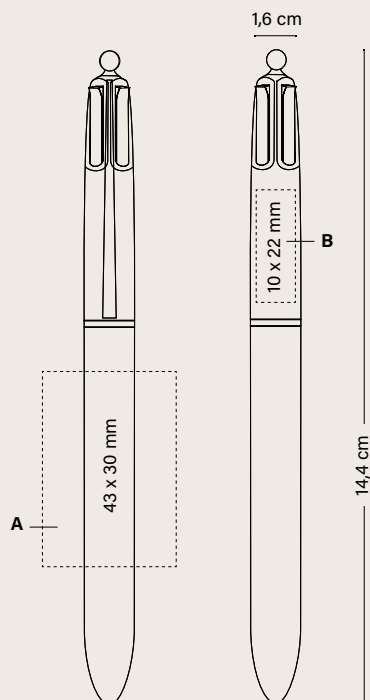

	Prezzo (€)				
BIC® 4 COLOURS® SOFT	250-499	500-999	1000-2499	2500-4999	5000
1060					
SP	4,18	3,78	3,50	3,28	3,09
1063 (Lanyard)					
SP	4,66	4,20	3,89	3,66	3,45
Costo di stampa aggiuntivo per colore e posizione					
SP	0,17	0,14	0,14	0,14	0,13
I prezzi includono serigrafia ad un colore in una posizione.					
Parte bianca superiore, 1 colore	0,17	0,14	0,14	0,14	0,13

CONFEZIONI SPECIALI OPZIONAL



ECO SLEEVE



PLASTIC POUCH



WINDOW BOX



COLLECTION BOX

Collection Box
(1, 2 e 3 pz.)



250 ± 3,2KG

+ INFO PAG. 240-245



COLORI PERSONALIZZATI



PRODOTTO E STAMPATO NEGLI STABILIMENTI BIC



PRODOTTO IN FRANCIA



CONFORMITÀ NORMATIVA



ISO certified



IMPRIM'VERT®



IL PROGRAMMA UBICITY™ CONSENTE DI RICICLARE GLI STRUMENTI DI SCRITTURA BIC



100% DI ELETTRICITÀ PROVENIENTE DA FONTI RINNOVABILI

MODALITÀ DI SCRITTURA



PENNA A SFERA M Ø 1 MM

TECNICHE DI STAMPA



SERIGRAFIA

Vedere pagina 250 per una spiegazione dettagliata delle icone.

BIC® 4 COLOURS® WOOD STYLE

Lasciati impressionare dalla spettacolare finitura in legno!



BIC® 4 COLOURS® WOOD STYLE

1061 Opaco
1064 Con Lanyard
Colore inchiostro
●●●●

NUOVO!



01/6AW

01/05W

01/02W

02/6AW

01/12W

Nuova area
di stampa

Dai calore al tuo
marchio



Servizio di ricarica
su richiesta

BIC® 4 COLOURS® WOOD STYLE

Personalizzazione

BIC® 4 COLOURS® WOOD STYLE

1061/1064

A SP: max. 2 col.

B SP: max. 1 col. (Solo per le parti superiori bianche)

MOQ 250 pz.

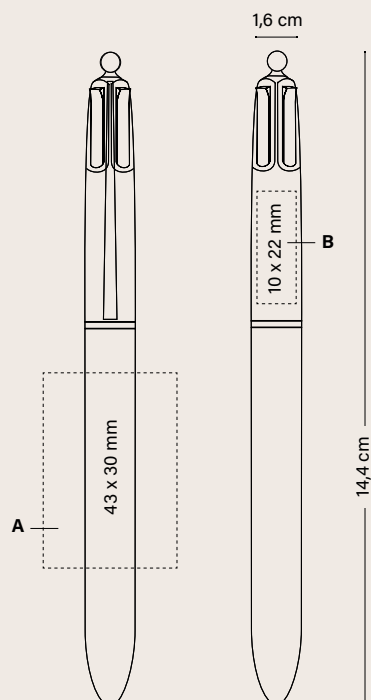

	Prezzo (€)				
BIC® 4 COLOURS® WOOD STYLE	250-499	500-999	1000-2499	2500-4999	5000
1061					
SP	4,18	3,78	3,50	3,28	3,09
1064 (Lanyard)					
SP	4,66	4,20	3,89	3,66	3,45
Costo di stampa aggiuntivo per colore e posizione					
SP	0,17	0,14	0,14	0,14	0,13
I prezzi includono serigrafia ad un colore in una posizione.					
Parte bianca superiore, 1 colore	0,17	0,14	0,14	0,14	0,13

CONFEZIONI SPECIALI OPZIONAL



ECO SLEEVE



PLASTIC POUCH



WINDOW BOX



COLLECTION BOX

Collection Box (1, 2 e 3 pz.)



250 ± 3,2KG

+ INFO PAG. 240-245

IMBALLAGGIO ESTERNO



COLORI PERSONALIZZATI



PRODOTTO E STAMPATO NEGLI STABILIMENTI BIC



PRODOTTO IN FRANCIA



CONFORMITÀ NORMATIVA



ISO certified



IL PROGRAMMA UBICIVITY™ CONSENTE DI RICICLARE GLI STRUMENTI DI SCRITTURA BIC



100% DI ELETTRICITÀ PROVENIENTE DA FONTI RINNOVABILI

MODALITÀ DI SCRITTURA



PENNA A SFERA M Ø 1 MM

TECNICHE DI STAMPA



SERIGRAFIA

Vedere pagina 250 per una spiegazione dettagliata delle icone.

BIC® 4 COLOURS® FLAGS COLLECTION

Celebra il patrimonio

BIC® 4 COLOURS® FLAGS COLLECTION

1067

1068 Con Lanyard

Colore inchiostro



01/03/47/05



01/02/03/12



01/03/47/04



01/03/12/03

NUOVO!

Nuova area di stampa



Servizio di ricarica su richiesta

BIC® 4 COLOURS® FLAGS COLLECTION

Personalizzazione

BIC® 4 COLOURS® FLAGS COLLECTION

1067/1068

A SP: max. 2 col.

B SP: max. 1 col.

MOQ 250 pz.

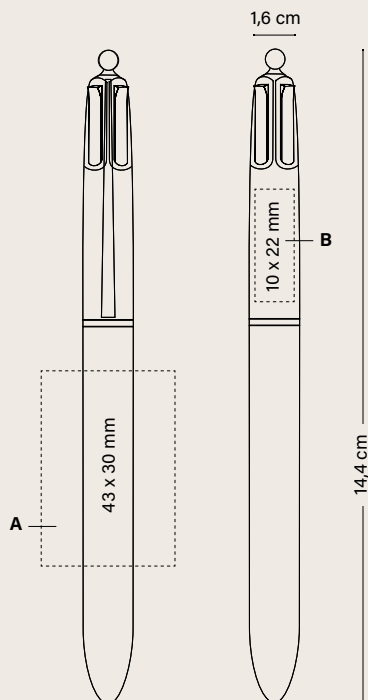

BIC® 4 COLOURS® FLAGS COLLECTION

	100-249	250-499	500-999	1000-2499	2500-4999	5000
1067						
SP	-	4,91	4,46	4,11	3,85	3,62
1068						
SP	-	5,41	4,91	4,51	5,24	3,99
Costo di stampa aggiuntivo per colore e posizione						
SP	-	0,17	0,14	0,14	0,14	0,13
Parte bianca superiore, 1 colore	-	0,17	0,14	0,14	0,14	0,13

I prezzi includono una stampa in una posizione secondo la tecnica specificata.

CONFEZIONI SPECIALI OPZIONAL



+ INFO PAG. 240-245

IMBALLAGGIO ESTERNO



Collection Box
(1, 2 e 3 pz.)



COLORI PERSONALIZZATI



PRODOTTO E STAMPATO NEGLI STABILIMENTI BIC



PRODOTTO IN FRANCIA



CONFORMITÀ NORMATIVA



IMPRIM'VERT®



IL PROGRAMMA UBICIVITY™ CONSENTE DI RICICLARE GLI STRUMENTI DI SCRITTURA BIC



100% DI ELETTRICITÀ PROVENIENTE DA FONTI RINNOVABILI

MODALITÀ DI SCRITTURA



PENNA A SFERA M Ø 1 MM

TECNICHE DI STAMPA



SERIGRAFIA

Vedere pagina 250 per una spiegazione dettagliata delle icone.

BIC® 4 COLOURS® 3+1^{HB}
1099 Opaco
Colore inchiostro
●●●●

3 penne + 1 matita portamine!



Personalizzazione

BIC® 4 COLOURS® 3+1^{HB}

1099 Opaco

A/B LE

MOQ 250 pz.
Combinazione colori standard

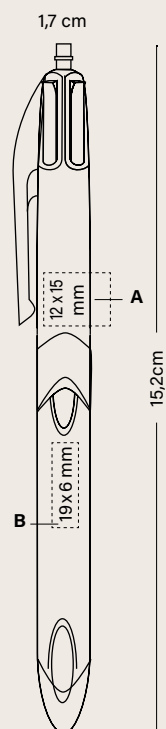

Prezzo (€)

BIC® 4 COLOURS® 3+1^{HB} 250-499 500-999 1000-2499 2500-4999 5000

1099

LE	5,27	4,77	4,43	4,12	3,90
-----------	------	------	------	------	------

Costo di stampa aggiuntivo per colore e posizione

LE	1,27	1,14	1,01	1,01	1,01
-----------	------	------	------	------	------

I prezzi includono una incisione laser in una posizione.

CONFEZIONI SPECIALI OPZIONALI



PLASTIC
POUCH



COLLECTION
BOX

Collection Box
(1, 2 e 3 pz.)

+ INFO PAG. 240-245

IMBALLAGGIO ESTERNO



250 ± 3,5 KG



COLORI
PERSONALIZZATI



PRODOTTO E STAMPATO
NEGLI STABILIMENTI BIC



CONFORMITÀ
NORMATIVA



IMPRIM'VERT®



IL PROGRAMMA UBICUITY™
CONSENTE DI RICICLARE GLI
STRUMENTI DI SCRITTURA BIC



100% DI ELETTRICITÀ
PROVENIENTE DA FONTI
RINNOVABILI

**MODALITÀ
DI SCRITTURA**



PENNA A SFERA M
Ø 1 MM



PORTAMINE
MP Ø 0,7MM

**TECNICHE
DI STAMPA**



LASER



GUARDA IL VIDEO

Vedere pagina 250 per una spiegazione dettagliata delle icone.

BIC® METAL PRO

Particolari metallici, design moderno e con una ampia selezione di colori e finiture.

BIC® METAL PRO

1290 Soft

Colore inchiostro



01F



02F



04F

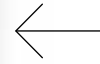

Massimo comfort di scrittura

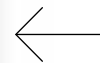

Inchiostro fabbricato in Germania, ti permette di scrivere fino a 8 Km

BIC® METAL PRO

1290 Lucido

Colore inchiostro



01E



02E



04E



05E



06P

100%

ASSEMBLAGGIO E STAMPA
NEGLI STABILIMENTI BIC

PRODOTTO IN
EUROPA

CONFORMITÀ
NORMATIVA

ISO
certified

IMPRIM'VERT®

IL PROGRAMMA UBICITY™
CONSENTE DI RICICLARE GLI
STRUMENTI DI SCRITTURA BIC

**MODALITÀ
DI SCRITTURA**

PENNA A SFERA M
Ø 1 MM

**TECNICHE DI
STAMPA**

SERIGRAFIA

LASER

Vedere pagina 250 per una spiegazione dettagliata delle icone.

BIC® METAL PRO

1290 Mate

Colore inchiostro



01D



02D



04D

100%

Personalizzazione

BIC® METAL PRO

1290

A SP: max. 2 col.

(Non disponibile nella finitura soft)

B LE/SP: max. 1 col.

C LE 360°

MOQ 50 pz.

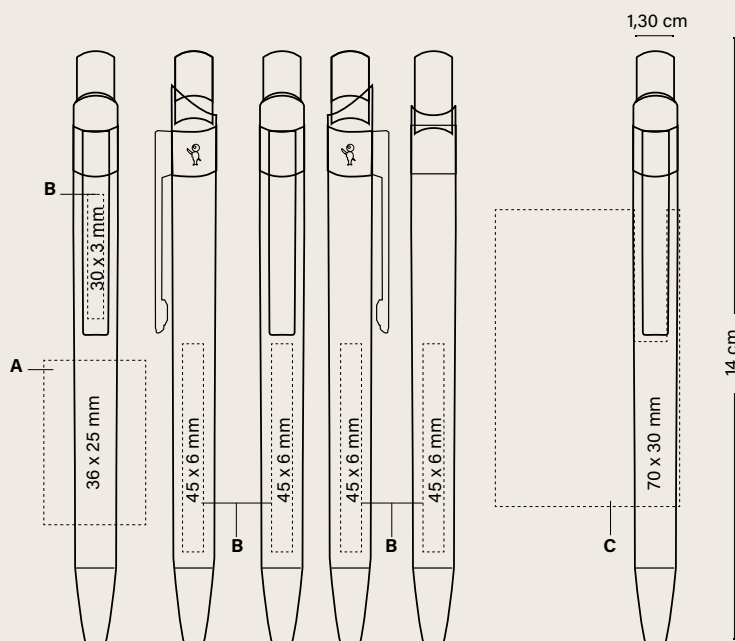

BIC® METAL PRO 1290	Prezzo (€)			
	50-99	100-249	250-499	500-1000
SP	5,12	4,81	4,59	4,37
LE	7,07	5,90	5,59	5,27
LE 360° (quantità minima 100 unità)	-	8,34	6,70	6,26

Costo di stampa aggiuntivo per colore e posizione

SP	0,45	0,42	0,37	0,32
LE	1,66	1,42	1,29	1,17

I prezzi includono una stampa in una posizione secondo la tecnica specificata.

CONFEZIONI SPECIALI OPZIONALI



+ INFO PAG. 240-245

IMBALLAGGIO ESTERNO



MODALITÀ DI SCRITTURA



TECNICHE DI STAMPA



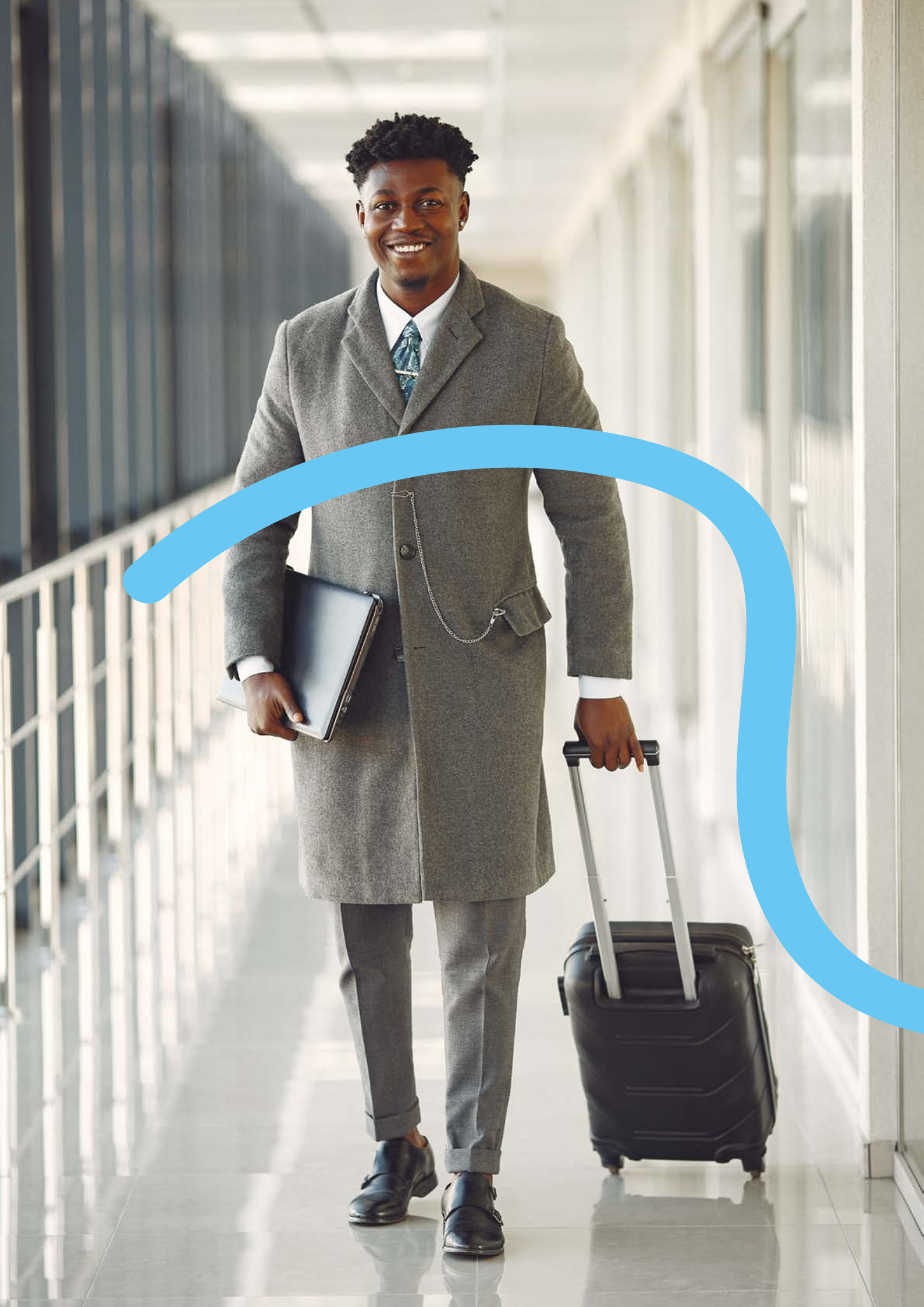

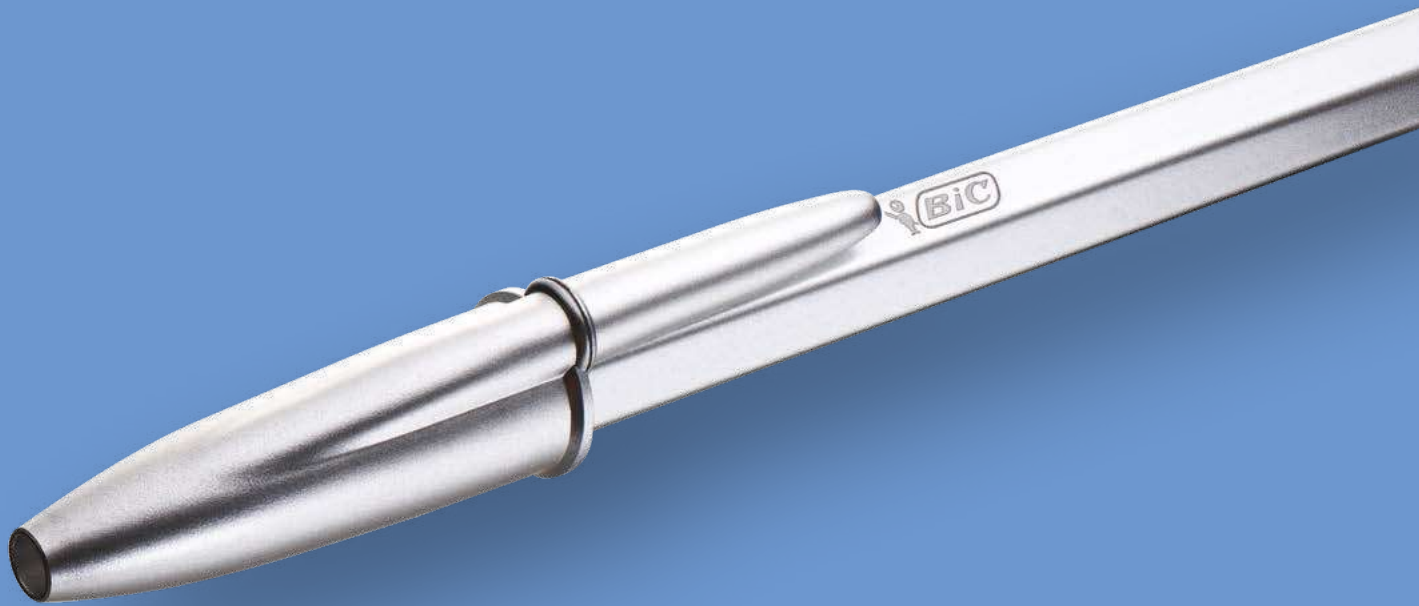

BIC® CRISTAL® RE'NEW™

L'iconica BIC® Cristal® in versione metallica. Penna a sfera ricaricabile premium BIC® Cristal® Re'New™ con inchiostro blu o nero e 2 ricariche incluse per continuare a scrivere a lungo. La penna presenta un resistente corpo in metallo argentato opaco e un cappuccio in plastica riciclata al 96%.

La stessa ingegnosa forma esagonale dell'originale BIC® Cristal® per una buona impugnatura e comfort. Design sostenibile, qualità e valore senza tempo. Il prodotto viene fornito nella scatola BIC® Window box.

BIC® CRISTAL® RE'NEW™

L'eleganza vestita di metallo.

BIC® CRISTAL®
RE'NEW™

1090

Colore inchiostro



18

18

18

100%

BIC® WINDOW BOX

1 PENNA + 2 RICARICHE

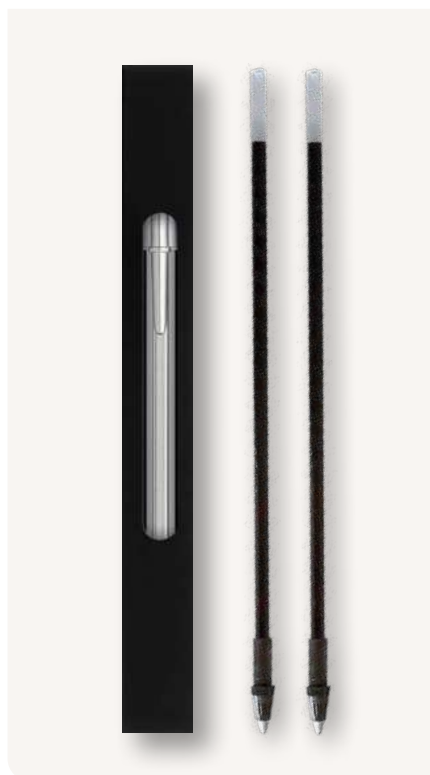

*La tua Cristal® Re'New™
sempre con questa confezione!!*

(Inclusa nel prezzo)

Personalizzazione

BIC® CRISTAL® RE'NEW™

1090

A LE: max. 1 col.

MOQ 25 pz.

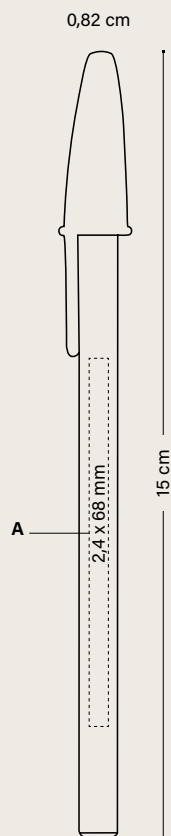

Prezzo (€)

BIC® CRISTAL® RE'NEW™	25-49	50-99	100-249	250-499	500-1000
1090					
LE	7,69	7,16	6,63	6,37	6,10

Costo di stampa aggiuntivo per colore e posizione

LE	1,98	1,66	1,42	1,29	1,17
----	------	------	------	------	------

I prezzi includono una incisione laser in una posizione.

IMBALLAGGIO ESTERNO



44 ± 1KG

PRODOTTO E STAMPATO
NEGLI STABILIMENTI BIC

CONFORMITÀ
NORMATIVA

ISO
certified

IMPRIM'VERT®

IL PROGRAMMA UBICITY™
CONSENTE DI RICICLARE GLI
STRUMENTI DI SCRITTURA BIC

**MODALITÀ
DI SCRITTURA**

PENNA A SFERA M
Ø 1 MM

**TECNICHE DI
STAMPA**

LASER

RICARICABILE

Vedere pagina 250 per una spiegazione dettagliata delle icone.





BIC[®] ROLLER & GEL

Goditi un'esperienza di scrittura morbidissima. Scorre facilmente sulla carta senza macchiare grazie all' inchiostro ad asciugatura immediata, ideale per mancini.

BIC[®] GRIP ROLLER

BIC[®] XS FINESTYLE

BIC[®] INTENSITY[®] GEL CLIC

BIC® GRIP ROLLER



SCRITTURA MEDIA
Ø 0,7 MM

Inchiostro liquido a punta media di alta qualità penna roller per una scrittura fluida

BIC® GRIP ROLLER

1187

Colore inchiostro



01/35

12/35

10/35

03/35

59/35

24/35

07/35

06/35

27/35

02/35

14/35

●
Anche disponibile
con inchiostro blu

●
Anche disponibile
con inchiostro blu

●
Anche disponibile
con inchiostro blu

100%

Personalizzazione

BIC® GRIP ROLLER

1187

A/B SP: max. 3 col.

MOQ 250 pz.

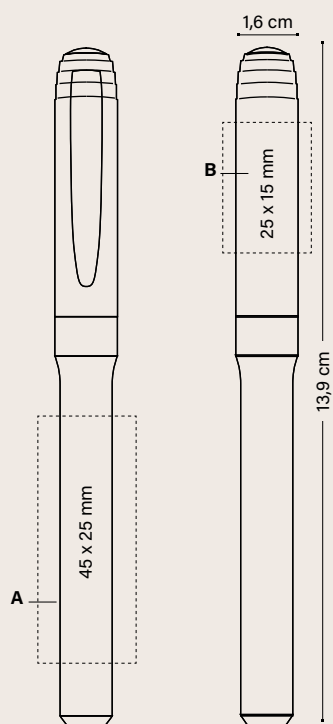

	Prezzo (€)				
BIC® GRIP ROLLER	250-499	500-999	1000-2499	2500-4999	5000
1187					
SP	1,86	1,68	1,56	1,46	1,37

Costo di stampa aggiuntivo per colore e posizione

SP	0,17	0,14	0,14	0,14	0,13
----	------	------	------	------	------

I prezzi includono serigrafia ad un colore in una posizione.

CONFEZIONI SPECIALI OPZIONALI



ECO SLEEVE

PLASTIC POUCH

WINDOW BOX

MARKING SET

COLLECTION BOX

+ INFO PAG. 240-245

IMBALLAGGIO ESTERNO



250 ± 3 KG

Collection Box
(1, 2 e 3 pz.)

PRODOTTO E STAMPATO
NEGLI STABILIMENTI BIC

CONFORMITÀ
NORMATIVA

ISO
certified

IMPRIM'VERT®

IL PROGRAMMA UBICIVITY™
CONSENTE DI RICICLARE GLI
STRUMENTI DI SCRITTURA BIC

MODALITÀ DI
SCRITTURA

ROLLER R
Ø 0,7 MM

TECNICHE DI
STAMPA

SP
SERIGRAFIA

Vedere pagina 250 per una spiegazione dettagliata delle icone.

BIC® XS FINESTYLE

1851 Opaco
Colore inchiostro



01/03



01/25



01/06

BIC® XS FINESTYLE

1851 Trasparente
Colore inchiostro



89/01

100%

●
Anche disponibile
con inchiostro nero

Personalizzazione

BIC® XS FINESTYLE

1851

A PD: max. 2 col.

B SP: max. 2 col.

C BP: full-colour

MOQ 250 pz.

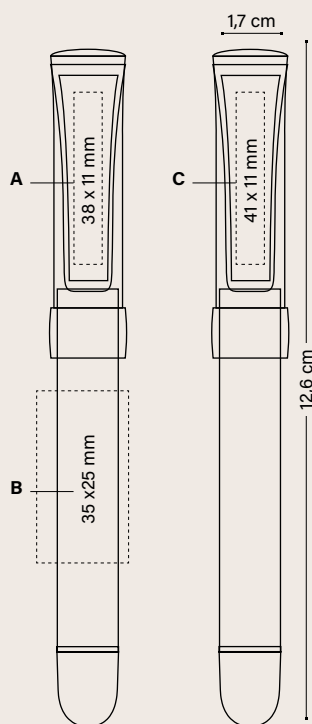

	Prezzo (€)				
BIC® XS FINESTYLE	250-499	500-999	1000-2499	2500-4999	5000
1851					
SP/PD	2,17	1,72	1,61	1,50	1,40
BP	2,24	1,95	1,83	1,71	1,59

Costo di stampa aggiuntivo per colore e posizione

SP/PD	0,17	0,14	0,14	0,14	0,13
BP Texture	0,18	0,16	0,15	0,15	0,14

I prezzi includono una stampa in una posizione secondo la tecnica specificata.

Esatta corrispondenza di colore: > 10.000 pz.

CONFEZIONI SPECIALI OPZIONALI



+ INFO PAG. 240-245



IMBALLAGGIO ESTERNO



MODALITÀ DI SCRITTURA



TECNICHE DI STAMPA



Vedere pagina 250 per una spiegazione dettagliata delle icone.



*L'iconico BIC® Boy
in rilievo*

BIC® INTENSITY® GEL CLIC

1196 Opaco
Colore inchiostro



01



02

100%

BIC® INTENSITY® GEL CLIC

1196 Trasparente
Colore inchiostro



92



88



86

100%

Personalizzazione

BIC® INTENSITY® GEL CLIC

1196

A SP: max. 2 col.

B SP: max. 4 col.

MOQ 250 pz.

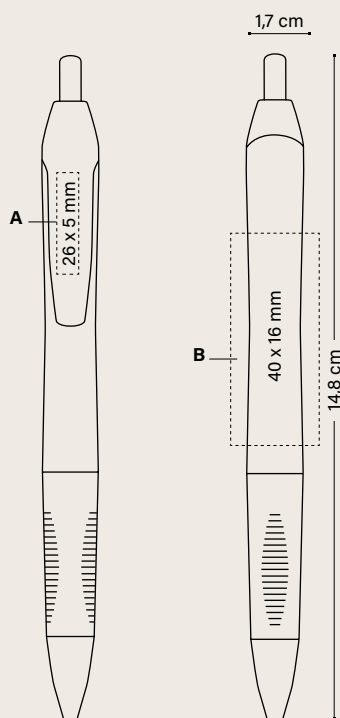

	Prezzo (€)				
BIC® INTENSITY® GEL CLIC	250-499	500-999	1000-2499	2500-4999	5000
1196					
SP	2,91	2,63	2,44	2,27	2,15
Costo di stampa aggiuntivo per colore e posizione					
SP	0,17	0,14	0,14	0,14	0,13

I prezzi includono serigrafia ad un colore in una posizione.

CONFEZIONI SPECIALI OPZIONALI



+ INFO PAG. 240-245

IMBALLAGGIO ESTERNO



PRODOTTI E STAMPATI
NEGLI STABILIMENTI BIC



CONFORMITÀ
NORMATIVA



ISO
certified



IMPRIM'VERT®



IL PROGRAMMA U-BICIVITY™
CONSENTE DI RICICLARE GLI
STRUMENTI DI SCRITTURA BIC

**MODALITÀ
DI SCRITTURA**



GEL G
Ø 0,7 MM

**TECNICHE DI
STAMPA**



SP
SERIGRAFIA

Vedere pagina 250 per una spiegazione dettagliata delle icone.



Ideas

EVIDENZIATORI E PENNARELLI BIC®

BIC® ti offre prodotti appositamente progettati per scrivere in modo ben visibile su superfici e materiali su cui altri strumenti di scrittura non possono scrivere. Rendi visibili le tue idee ed esprimi su qualsiasi superficie con pennarelli BIC®.

BIC® BRITE LINER® GRIP

BIC® VELLEDA® WHITE BOARD MARKER FINE

BIC® VELLEDA® WHITE BOARD MARKER GRIP

BIC® MARK-IT PERMANENT MARKER

BIC® PERMANENT MARKER ECOLUTIONS®



BIC® BRITE LINER® GRIP

BIC® BRITE LINER® GRIP
1192



Grip di gomma per una maggiore precisione e controllo

12 10 24 59 14
● ● ● ● ●
Colore inchiostro Colore inchiostro Colore inchiostro Colore inchiostro Colore inchiostro

Personalizzazione

BIC® BRITE LINER® GRIP

1192

A/B SP: max. 3 col.

MOQ 250 pz.

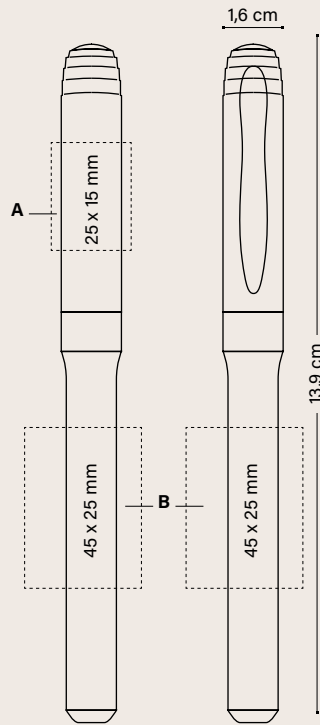

	250-499	500-999	1000-2499	2500-4999	Prezzo (€)
BIC® BRITE LINER® GRIP					5000
1192					
SP	1,67	1,54	1,42	1,31	1,23
Costo di stampa aggiuntivo per colore e posizione					
SP	0,17	0,14	0,14	0,14	0,13

I prezzi includono serigrafia ad un colore in una posizione.

CONFEZIONI SPECIALI OPZIONALI



MARKING SET



COLLECTION BOX

Collection Box
(1, 2 e 3 pz.)

+ INFO PAG. 240-245

IMBALLAGGIO ESTERNO



250 ± 2,8KG



PRODOTTO E STAMPATO
NEGLI STABILIMENTI BIC



CONFORMITÀ
NORMATIVA



ISO
certified



IMPRIM'VERT®



IL PROGRAMMA UBI-CITY™
CONSENTE DI RICICLARE GLI
STRUMENTI DI SCRITTURA BIC



NON SI SECCA 24H

MODALITÀ
DI SCRITTURA



EVIDENZIATORE HL

TECNICHE DI
STAMPA



SP
SERIGRAFIA

ADATTO PER



FAX



FOTOCOPIE



STAMPANTI



CARTA

Vedere pagina 250 per una spiegazione dettagliata delle icone.

BIC® VELLEDA® WHITE BOARD MARKER FINE

Velleda®

BIC® VELLEDA® WHITE BOARD MARKER FINE
1651



01/04

●
Colore inchiostro



100%

01/02

●
Colore inchiostro

Personalizzazione

BIC® VELLEDA® WHITE BOARD MARKER FINE
1651

A SP: max. 1 col.

MOQ 500 pz.

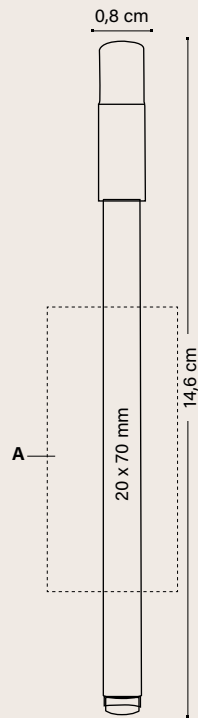

Prezzo (€)

BIC® VELLEDA® WHITE BOARD MARKER FINE

1651

SP	500-999	1000-2499	2500-4999	5000
	0,60	0,54	0,51	0,48

I prezzi includono serigrafia ad un colore in una posizione.

CONFEZIONI SPECIALI OPZIONALI



MARKING SET

Ora puoi averlo in set!

+ INFO PAG. 240-245

IMBALLAGGIO ESTERNO



500 ± 3,2KG



PRODOTTO E STAMPATO NEGLI STABILIMENTI BIC



PRODOTTO IN FRANCIA



CONFORMITÀ NORMATIVA



ISO certified



IMPRIM'VERT®



IL PROGRAMMA UBICUITY™ CONSENTE DI RICICLARE GLI STRUMENTI DI SCRITTURA BIC



UNTA RESISTENTE HL



PENNARELLO MK



SP

SERIGRAFIA

BIC® VELLEDA® WHITE BOARD MARKER GRIP

Velleda®

BIC® VELLEDA® WHITE BOARD MARKER GRIP

1213



100%

01/02
●
Colore inchiostro

→
Grip di gomma per una maggiore precisione e controllo

Personalizzazione

BIC® VELLEDA® WHITE BOARD MARKER GRIP

1213

A/B SP: max. 3 col.

MOQ 250 pz.

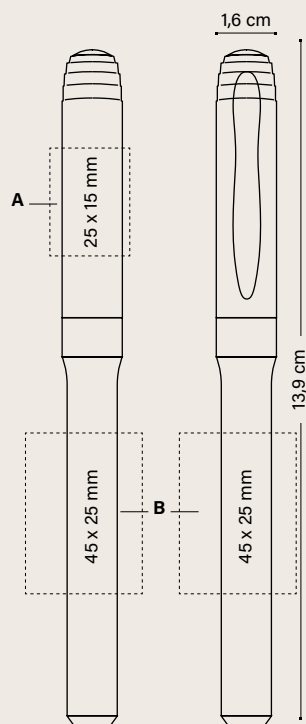

Prezzo (€)

BIC® VELLEDA® WHITE BOARD MARKER GRIP

1213

SP	1,64	1,48	1,37	1,27	1,19
----	------	------	------	------	------

Costo di stampa aggiuntivo per colore e posizione

SP	0,17	0,14	0,14	0,14	0,13
----	------	------	------	------	------

I prezzi includono serigrafia ad un colore in una posizione.

CONFEZIONI SPECIALI OPZIONALI



MARKING SET



250 ± 2,7KG

Ora puoi averlo in set!

+ INFO PAG. 240-245



PRODOTTO E STAMPATO NEGLI STABILIMENTI BIC



CONFORMITÀ NORMATIVA



IL PROGRAMMA UBICIVITY™ CONSENTE DI RICICLARE GLI STRUMENTI DI SCRITTURA BIC



UNTA RESISTENTE HL



PENNARELLO MK



SERIGRAFIA

MODALITÀ DI SCRITTURA

TECNICHE DI STAMPA

BIC® MARK-IT PERMANENT MARKER

**BIC® MARK-IT
PERMANENT
MARKER**
1214



01/02
●
Colore
inchiostro

01/04
●
Colore
inchiostro

100%

←
*Grip di gomma
per una maggiore
precisione e controllo*

Personalizzazione

**BIC® MARK-IT
PERMANENT MARKER**
1214

A/B SP: max. 3 col.

MOQ 250 pz.

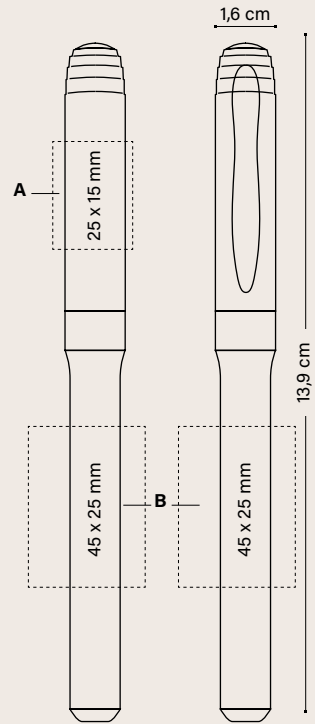

	Prezzo (€)				
BIC® MARK-IT PERMANENT MARKER 1214	250- 499	500- 999	1000- 2499	2500- 4999	5000
SP	1,61	1,45	1,35	1,25	1,17

Costo di stampa aggiuntivo per colore e posizione					
SP	0,17	0,14	0,14	0,14	0,13

I prezzi includono serigrafia ad un colore in una posizione.

CONFEZIONI SPECIALI OPZIONALI

IMBALLAGGIO ESTERNO



MARKING
SET



250 ± 2,8KG

*Ora puoi
averlo in set!*

+ INFO PAG. 240-245



PRODOTTO E STAMPATO
NEGLI STABILIMENTI BIC



CONFORMITÀ
NORMATIVA



IL PROGRAMMA UBICUITY™
CONSENTE DI RICICLARE GLI
STRUMENTI DI SCRITTURA BIC



PUNTA
RESISTENTE



MODALITÀ DI SCRITTURA
PENNARELLO
MK

TECNICHE DI STAMPA



SERIGRAFIA

BIC® PERMANENT MARKER ECOLUTIONS®

ecolutions®

ecolutions



REALIZZATA CON IL
51% DI MATERIALE RICICLATO*

Aggiungi il Mobius loop alla tua grafica senza costi addizionali. Si prega di specificarlo nell'ordine. La stampa del Mobius loop viene fatta di default nell'angolo a sinistra.



IMBALLAGGI
FARMACEUTICI

BIC® PERMANENT MARKER ecolutions® 1210



02

●
Colore inchiostro

02

●
Colore inchiostro

100%

Personalizzazione

BIC® PERMANENT MARKER ecolutions® 1210

A SP: max. 1 col.

MOQ 250 pz.

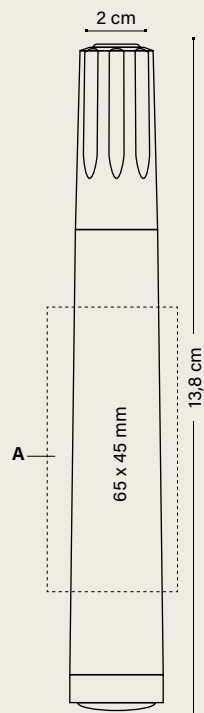

	Prezzo (€)				
BIC® PERMANENT MARKER ecolutions® 1210	250-499	500-999	1000-2499	2500-4999	5000
SP	1,90	1,73	1,60	1,50	1,41

I prezzi includono serigrafia ad un colore in una posizione.

IMBALLAGGIO ESTERNO



PRODOTTO E STAMPATO NEGLI STABILIMENTI BIC

FABRIQUÉ EN FRANCE



CONFORMITÀ NORMATIVA



IMPRIM'VERT®
ecolutions®



IMBALLAGGI FARMACEUTICI



PUNTA RESISTENTE

MODALITÀ DI SCRITTURA



PENNARELLO MK

TECNICHE DI STAMPA



SERIGRAFIA

* La percentuale viene calcolata sul peso totale del prodotto escluso il sistema d'inchiostro. A causa del contenuto riciclato delle materie prime con cui è realizzato il prodotto, non siamo in grado di garantire che i colori che appaiono in catalogo, né quelli personalizzati su richiesta, abbiano sempre lo stesso colore e aspetto. Vedere pagina 250 per una spiegazione dettagliata delle icone.



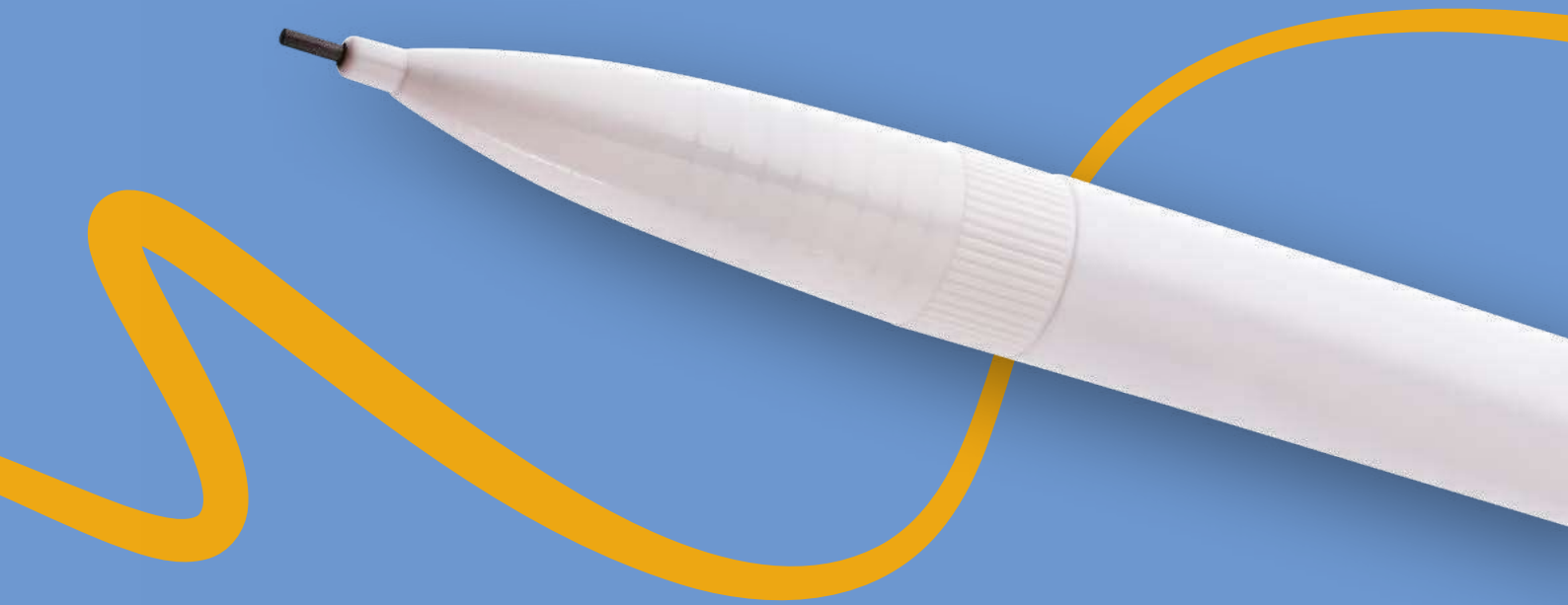

PORTAMINE BIC®

Sempre pronto con questo portamine di qualità superiore.
È solido e resistente, non ha bisogno di essere temperato e
scrive in modo più morbido e intenso che mai!

BIC® MATIC®

BIC® MEDIA CLIC PORTAMINE

BIC® MEDIA CLIC GRIP PORTAMINE

Versione ECO. Allo stesso prezzo della versione standard!

ecolutions®



REALIZZATA CON IL 65% DI MATERIALE RICICLATO*

Aggiungi il Mobius loop alla tua grafica senza costi aggiuntivi. Si prega di specificarlo nell'ordine. La stampa del Mobius loop viene fatta di default nell'angolo a sinistra.



IMBALLAGGI FARMACEUTICI

BIC® MATIC®
1120 Opaco



BIC® MATIC®
ecolutions® 1E40 Opaco



*La percentuale è calcolata sul peso totale del prodotto. A causa del contenuto riciclato delle materie prime con cui è realizzato il prodotto, non siamo in grado di garantire che i colori che appaiono in catalogo, né quelli personalizzati su richiesta, abbiano sempre lo stesso colore e aspetto.

Personalizzazione

BIC® MATIC®
1120
ecolutions® 1E40
MOQ 500 pz.

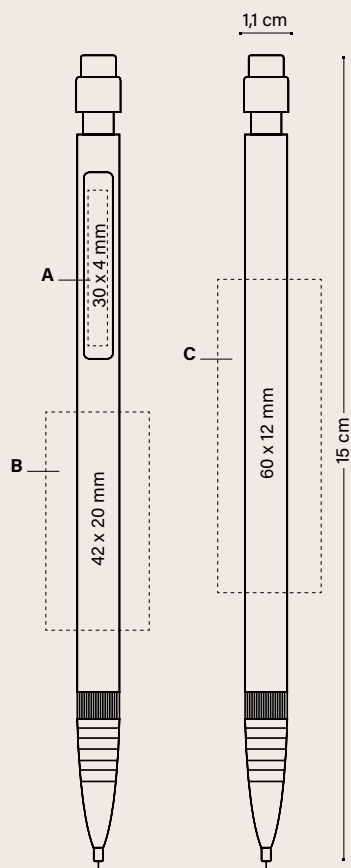

	500-999	1000-2499	2500-4999	5000
BIC® MATIC®				Prezzo (€)
1120/ ecolutions® 1E40				
SP	0,82	0,77	0,71	0,67
Costo di stampa aggiuntivo per colore e posizione				
SP	0,14	0,14	0,14	0,13

I prezzi includono serigrafia ad un colore in una posizione.

CONFEZIONI SPECIALI OPZIONALI



PLASTIC
POUCH

+ INFO PAG. 240-245

IMBALLAGGIO ESTERNO



500 ± 3,1 KG



PRODOTTO E STAMPATO
NEGLI STABILIMENTI BIC



FABRIQUE
EN FRANCE

PRODOTTO IN FRANCIA



CONFORMITÀ
NORMATIVA



IMPRIM'VERT®

ecolutions®



IMBALLAGGI
FARMACEUTICI



RICICLABILE



SCRITTURA PIÙ
DELICATA E SCURA



FACILE DA USARE E
DA CANCELLARE



2 MINE DI 9 CM

MODALITÀ
DI SCRITTURA



PORTAMINE MP
Ø 0,7 MM

TECNICHE DI
STAMPA



SERIGRAFIA

Vedere pagina 250 per una spiegazione dettagliata delle icone.

BIC® MEDIA CLIC PORTAMINE



L' iconico BIC® Boy è inciso!

BIC® MEDIA CLIC
1028 Portamine
Opaco



8D



5C



13



83

BIC® MEDIA CLIC
1028 Portamine
Frosted



3B



39

BIC® MEDIA CLIC GRIP PORTAMINE

Versione ECO.
Allo stesso prezzo della versione standard!

ecolutions®

REALIZZATA CON IL 92%
DI MATERIALE RICICLATO*



PARTI IN PLASTICA
PER AUTOVEICOLI

BIC® MEDIA CLIC GRIP
1021 Portamine
Opaco

Stampa a
360°



01/12

100%

BIC® MEDIA CLIC GRIP
1021 Portamine
Frosted



69/69

71/69

82/69

BIC® MEDIA CLIC GRIP
1E21 Portamine
Opaco



40/69

100%

01/03

01/05

01/02

01/07

100%

Disponibile
in fusto bianco



*La percentuale è calcolata sul peso totale del prodotto. A causa del contenuto riciclato delle materie prime con cui è realizzato il prodotto, non siamo in grado di garantire che i colori che appaiono in catalogo, né quelli personalizzati su richiesta, abbiano sempre lo stesso colore e aspetto.

BIC® MEDIA CLIC PORTAMINE

BIC® MEDIA CLIC

1028 Portamine

BIC® MEDIA CLIC GRIP

1021 Portamine / **ecolutions®** 1E21 Portamine



MOQ 500 pz.
Combinazione colori standard

Nessun costo aggiuntivo

Clip



Opaco

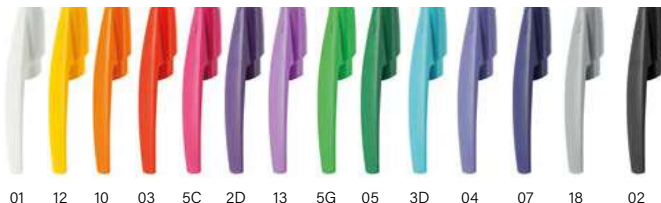

Frosted



01

12

10

03

5C

2D

13

5G

05

3D

04

07

18

02

69

Fusto



Opaco

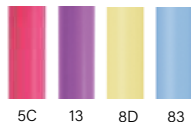

5C

13

8D

83

Frosted



39

3B

Corpo & Impugnatura



01/12

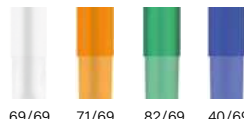

69/69

71/69

82/69

40/69



LA SOLUZIONE PER LA
COMUNICAZIONE FULL
COLOUR!

ecolutions®



PARTI IN PLASTICA
PER AUTOVEICOLI

Combinazione colori
standard**

Corpo & Impugnatura

Opaco



01/
03

01/
05

01/
07

01/
02



Aggiungi il Mobius loop alla
tua grafica senza
costi aggiuntivi. Si prega di
specificarlo nell'ordine.
La stampa del Mobius
loop viene fatta di default
nell'angolo a sinistra.

Tutta la gamma di colori disponibile in BritePix™ Digital

Esatta corrispondenza di colore: ≥ 10.000 pz. 1028

Esatta corrispondenza di colore: ≥ 20.000 pz. 1021 / 1E21



COLORI
PERSONALIZZATI



PRODOTTO E
STAMPATO
NEGLI STABIL-
MENTI BIC

**MIX &
MATCH**
ecolutions®



PARTI IN
PLASTICA PER
AUTOVEICOLI



RICICLABILE

MODALITÀ DI SCRITTURA



PORTAMINE
MP

TECNICHE DI STAMPA



SP SERIGRAFIA



DG DIGITALE

BIC® MEDIA CLIC / BIC® MEDIA CLIC GRIP PORTAMINE

BIC® MEDIA CLIC

1028 Portamine

A SP: max. 4 col.

B SP: max. 2 col.

C DG: full-colour

MOQ 500 pz.

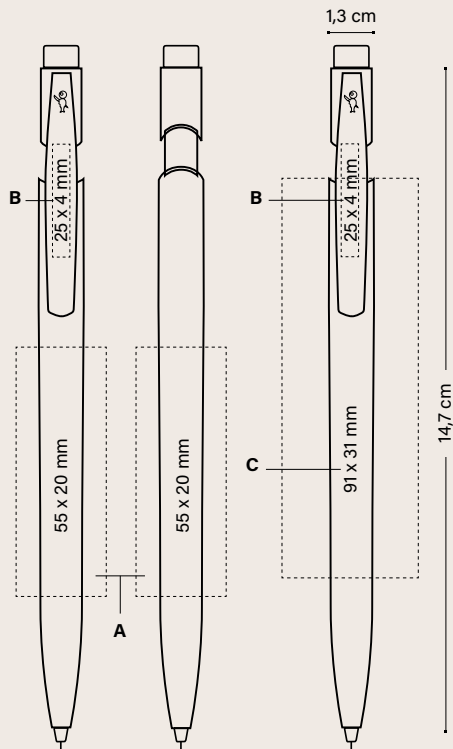

	Prezzo (€)			
BIC® MEDIA CLIC	500-999	1000-2499	2500-4999	5000
1028 (Portamine)				
SP	0,87	0,78	0,73	0,67
DG	1,08	0,97	0,87	0,77

Costo di stampa aggiuntivo per colore e posizione

SP	0,14	0,14	0,14	0,13
----	------	------	------	------

I prezzi includono una stampa in una posizione secondo la tecnica specificata.

CONFEZIONI SPECIALI OPZIONALI



+ INFO PAG. 240-245

IMBALLAGGIO ESTERNO



BIC® MEDIA CLIC GRIP

1021 Portamine

ecolutions® 1E21 Portamine

D SP: max. 4 col.

E SP: max. 2 col.

F DG: full-colour

MOQ 500 pz.

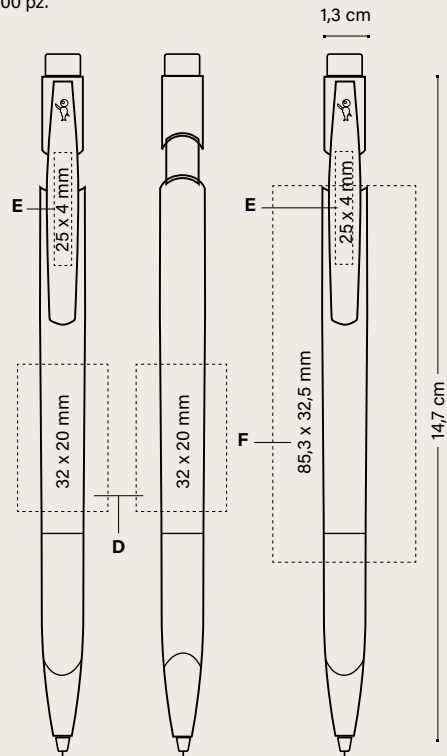

	Prezzo (€)			
BIC® MEDIA CLIC GRIP	500-999	1000-2499	2500-4999	5000
1021 / ecolutions® 1E21 (Portamine)				
SP	1,08	0,94	0,83	0,76
DG	1,37	1,28	1,09	0,99

Costo di stampa aggiuntivo per colore e posizione

SP	0,14	0,14	0,14	0,13
----	------	------	------	------

I prezzi includono una stampa in una posizione secondo la tecnica specificata.

CONFEZIONI SPECIALI OPZIONALI



+ INFO PAG. 240-245

IMBALLAGGIO ESTERNO



PRODOTTO E STAMPATO NEGLI STABILIMENTI BIC



MODALITÀ DI SCRITTURA



TECNICHE DI STAMPA





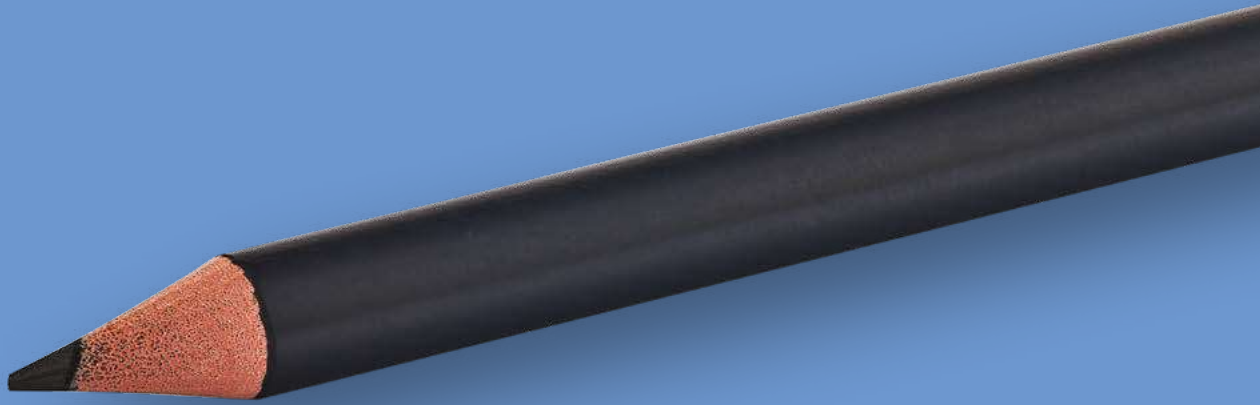

MATITE BIC[®]

Matita senza legno realizzata in resina sintetica riciclata che non produce schegge in caso di rottura. Mina HB in grafite ultrasistente.

EVOLUTION[®] ECOLUTIONS[®]



LA SOLUZIONE PER
LA COMUNICAZIONE
FULL COLOUR



LA SOLUZIONE PER
LA COMUNICAZIONE
FULL COLOUR



L'iconico marchio
BIC® in rilievo!

ecolutions®



REALIZZATA CON IL 60%
DI MATERIALE RICICLATO*



FRIGORIFERI E
CONTENITORI DI YOGURT

ecolutions®



REALIZZATA CON IL 52,7%
DI MATERIALE RICICLATO*



FRIGORIFERI E
CONTENITORI DI YOGURT

MATITA DI GRAFITE
SENZA GOMMA
ecolutions® 1150

MATITA GRAFICA
CON GOMMA
ecolutions® 1151



Proteggi
mina



*La percentuale è calcolata sul peso totale del prodotto. A causa del contenuto riciclato delle materie prime con cui è realizzato il prodotto, non siamo in grado di garantire che i colori che appaiono in catalogo, né quelli personalizzati su richiesta, abbiano sempre lo stesso colore e aspetto.

ecolutions®
 REALIZZATA CON IL 60%
 DI MATERIALE RICICLATO*



Aggiungi il Mobius loop alla tua grafica senza costi aggiuntivi. Si prega di specificarlo nell'ordine. La stampa del Mobius loop viene fatta di default nell'angolo a sinistra.

**MATITA DI GRAFITE CON
 E SENZA GOMMA**
 1150/1151

MOQ 500 pz.
 Combinazione colori standard

Gomma

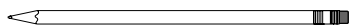

Opaco



Ferula

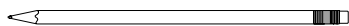

Opaco



Fusto



Opaco

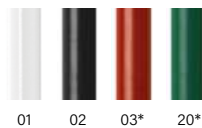

Nessun costo aggiuntivo



PRODOTTO E STAMPATO
 NEGLI STABILIMENTI BIC



PRODOTTO IN FRANCIA



CONFORMITÀ
 NORMATIVA



ecolutions®



RICICLABILE



PUNTA RESISTENTE



NON SI
 SCHEGGIA



PROTEGGI
 MINA



FACILE DA USARE
 E DA CANCELLARE

**MODALITÀ
 DI SCRITTURA**



MATITA PC HB
 Ø 2,3MM

**TECNICHE DI
 STAMPA**



SERIGRAFIA



DIGITALE

Vedere pagina 250 per una spiegazione dettagliata delle icone.



Personalizzazione

BIC® EVOLUTION® ECOLUTIONS®
ecolutions® 1150 (Matita senza gomma)

A SP: max. 1 col.

MOQ 500 pz.

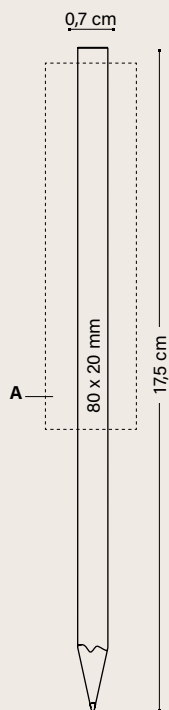

Personalizzazione

BIC® EVOLUTION® ECOLUTIONS®
ecolutions® 1151 (Matita con gomma)

MOQ 500 pz.

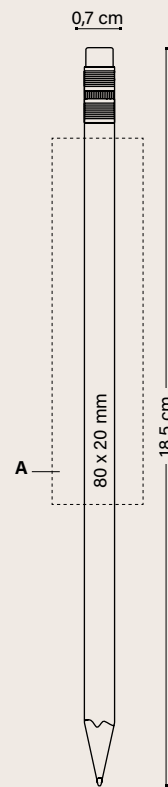

				Prezzo (€)
BIC® EVOLUTION® ecolutions®	500-999	1000-2499	2500-4999	5000
1150				
SP	0,50	0,47	0,44	0,42
1151				
SP	0,85	0,80	0,75	0,71

I prezzi includono serigrafia ad un colore in una posizione.

CONFEZIONI SPECIALI OPZIONALI



PLASTIC
 POUCH
 (x 3 PZ.)

*Ora puoi
 averlo in set!*

+ INFO PAG. 240-245

IMBALLAGGIO ESTERNO



500 ± 3,5 KG

Personalizzazione

BIC® EVOLUTION® ECOLUTIONS®
ecolutions® 1150 (Matita senza gomma digitale)

A DG: full-colour (area per le immagini)

MOQ 500 pz.

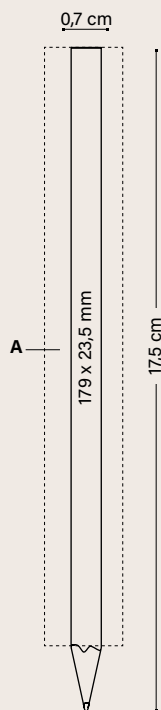

Personalizzazione

BIC® EVOLUTION® ECOLUTIONS®
ecolutions® 1151 (Matita con gomma digitale)

MOQ 500 pz.

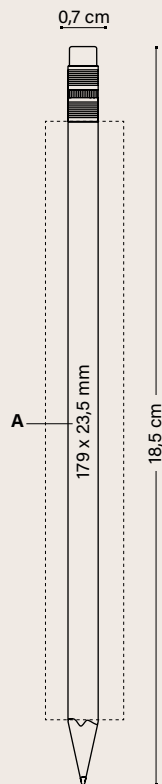

	Prezzo (€)			
BIC® EVOLUTION® ecolutions®	500-999	1000-2499	2500-4999	5000
1150				
DG	0,78	0,75	0,70	0,65
1151				
DG	1,14	1,07	1,00	0,94

I prezzi includono stampa digitale sul corpo.

CONFEZIONI SPECIALI OPZIONALI



PLASTIC
POUCH
(X 3 PZ.)

*Ora puoi
averlo in set!*

+ INFO PAG. 240-245

IMBALLAGGIO ESTERNO



500 ± 3,5 KG

**MIX &
MATCH**



PRODOTTO E STAMPATO
NEGLI STABILIMENTI BIC

**FABRIQUÉ
EN FRANCE**

PRODOTTO IN FRANCIA



CONFORMITÀ
NORMATIVA



IMPRIM'VERT®
ecolutions®



FRIGORIFERI E
CONTENITORI DI YOGURT



RICICLABILE



PUNTA RESISTENTE



NON SI SCHEGGIA



PROTEGGI
MINA



FACILE DA USARE
E DA CANCELLARE

**MODALITÀ
DI SCRITTURA**



MATITA PC HB
Ø 2,3MM

**TECNICHE DI
STAMPA**



SERIGRAFIA



DIGITALE

Vedere pagina 250 per una spiegazione dettagliata delle icone.

SPROUT™ MATITA DI GRAFITE



La matita sostenibile che può essere piantata dopo essere stata utilizzata e cresce come un'erba, un vegetale o un fiore.

SPROUT™ MATITA DI GRAFITE
53062

Con i semi



Fusto Standard

Fusti Personalizzabili

Cartoncino Standard



Cartone non personalizzabile

Cartoncino personalizzabile



Cartone personalizzabile



Parte posteriore



Punta in Grafite

Quando la matita diventa troppo corta per scrivere, si può piantare trasformando il proprio messaggio in un bellissimo vaso di erbe aromatiche, fiori o verdure.

Scegli tra 8 semi diversi

- | | |
|--------------------------------|------------------------------|
| 1. <i>Abete</i> | 5. <i>Basilico</i> |
| 2. <i>Girasole</i> | 6. <i>Timo</i> |
| 3. <i>Margherita</i> | 7. <i>Salvia</i> |
| 4. <i>Non ti scordar di me</i> | 8. <i>Pomodoro ciliegino</i> |

Personalizzazione

SPROUT™ MATITA DI GRAFITE

53062

A LE
B DG

MOQ 100 pz.

L'affilatura delle matite è offerta con un supplemento di prezzo.

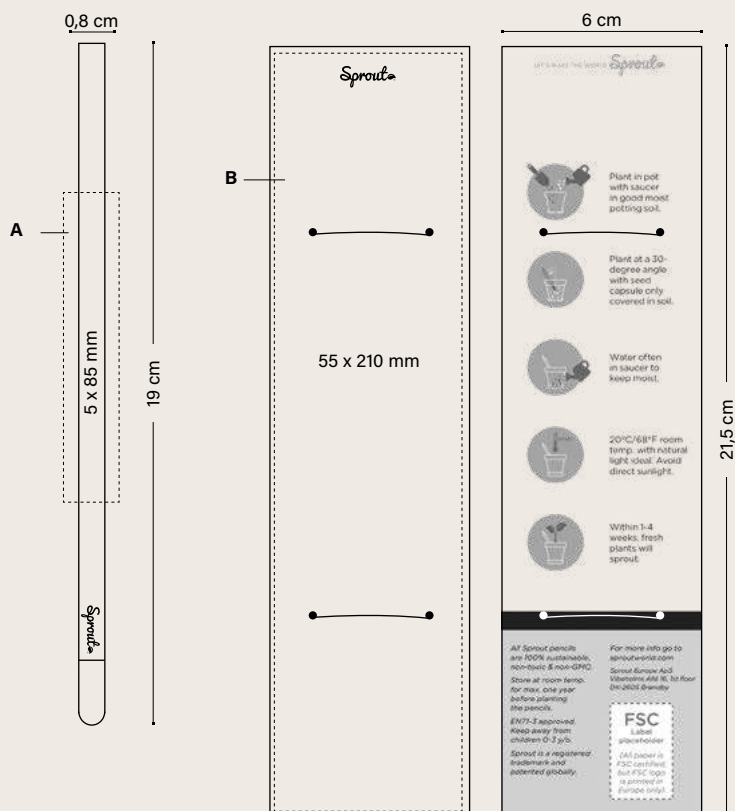

Istruzioni per piantare incluse sul retro.

Possibilità di personalizzare il cartoncino cambiando caratteri e colori!

SPROUT™ MATITA DI GRAFITE 53062	Prezzo (€)				
	100	250	500	1000	2500
Matita con incisione laser	1,860	1,730	1,570	1,470	1,390
Matita incisa + Cartone standard	0,360	0,340	0,330	0,300	0,290
Matita incisa + Cartone personalizzabile	3,020	1,410	1,320	1,250	0,670

IMBALLAGGIO ESTERNO



500 ± 2,5 KG (SOLO MATITA)
± 5 KG (CON IMBALLO IN CARTONE)

IMBALLAGGIO



FOREST
STEWARDSHIP
COUNCIL



Sprout



FSC E CARTONE
RICICLABILE



RICICLABILE

MODALITÀ DI SCRITTURA



MATITA PC HB
Ø 2,3MM

TECNICHE DI STAMPA



LASER



DIGITALE



GUARDA IL VIDEO

Vedere pagina 250 per una spiegazione dettagliata delle icone.

Tabella dei Contenuti

02

ALTRI STRUMENTI DI SCRITTURA

PENNE IN PLASTICA

Basic Pen	182
Click Pen	184
Striped Grip Pen	186

PENNE STYLUS

Sleek Stylus Pen	188
------------------	-----

BASIC PEN

BASIC PEN

12010

Colore inchiostro



Personalizzazione

BASIC PEN 12010

A/B SP: max. 1 col.

MOQ 500 pz.

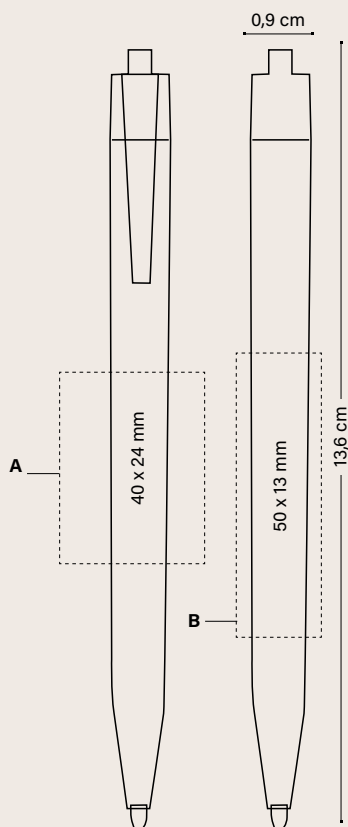

BASIC PEN 12010	Prezzo (€)			
	500-999	1000-2499	2500-4999	5000
Neutro	0,17	0,16	0,16	0,15
SP	0,68	0,54	0,46	0,42

I prezzi includono serigrafia ad un colore in una posizione.

IMBALLAGGIO ESTERNO



1000 ± 12,5 KG



STAMPATO NEGLI
STABILIMENTI BIC



QUALITÀ E SICUREZZA
APPROVATO



CONFORMITÀ
NORMATIVA



ISO
certified



IMPRIM'VERT®

MODALITÀ DI SCRITTURA



PENNA A SFERA M
Ø 1 MM

TECNICHE DI STAMPA



SP
SERIGRAFIA

CLICK PEN

CLICK PEN

11748

Colore inchiostro



Personalizzazione

CLICK PEN

11748

A/B SP: max. 4 col.

C/D PD: max. 4 col.

MOQ 500 pz.

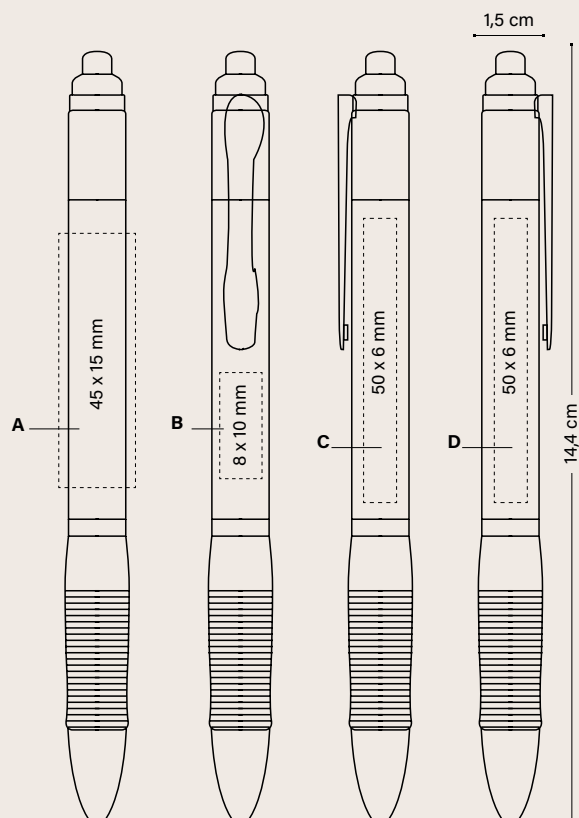

CLICK PEN	Prezzo (€)			
	500-999	1000-2499	2500-4999	5000
11748				
Neutro	0,22	0,21	0,21	0,20
SP	0,66	0,54	0,46	0,43
PD	0,81	0,64	0,55	0,50

Costo di stampa aggiuntivo per colore e posizione

SP	0,14	0,14	0,14	0,13
PD	0,37	0,27	0,20	0,19

I prezzi includono una stampa in una posizione secondo la tecnica specificata.

IMBALLAGGIO ESTERNO



MODALITÀ DI SCRITTURA



TECNICHE DI STAMPA



STRIPED GRIP PEN

STRIPED GRIP PEN

11243

Colore inchiostro



10



03



24



8C



04

100%

Personalizzazione

STRIPED GRIP PEN

11243

A SP: max. 2 col.

B PD: max. 1 col.

MOQ 500 pz.

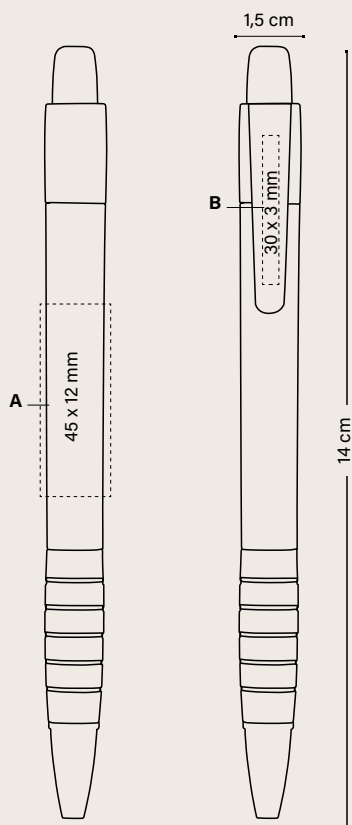

Prezzo (€)

STRIPED GRIP PEN	500-999	1000-2499	2500-4999	5000
11243				
Neutro	0,35	0,34	0,34	0,32
SP	0,78	0,65	0,58	0,54
PD	0,85	0,76	0,66	0,61

Costo di stampa aggiuntivo per colore e posizione

SP	0,14	0,14	0,14	0,13
PD	0,37	0,27	0,20	0,19

I prezzi includono una stampa in una posizione secondo la tecnica specificata.

IMBALLAGGIO ESTERNO



MODALITÀ DI SCRITTURA



TECNICHE DI STAMPA



SLEEK STYLUS PEN

SLEEK STYLUS PEN

11666

Colore inchiostro



01

SLEEK STYLUS MATT PEN

11747

Colore inchiostro



47



04

SLEEK STYLUS EXECUTIVE PEN

11976



26

Disponibile in
inchiostro blu



2N

Disponibile con
inchiostro nero

Personalizzazione

SLEEK STYLUS PEN

11666

SLEEK STYLUS MATT PEN

11747

SLEEK STYLUS EXECUTIVE PEN

11976

A SP: max. 1 col.

B SP: max. 2 col.

C LE

MOQ 500 pz. (SP)

MOQ 100 pz. (LE)

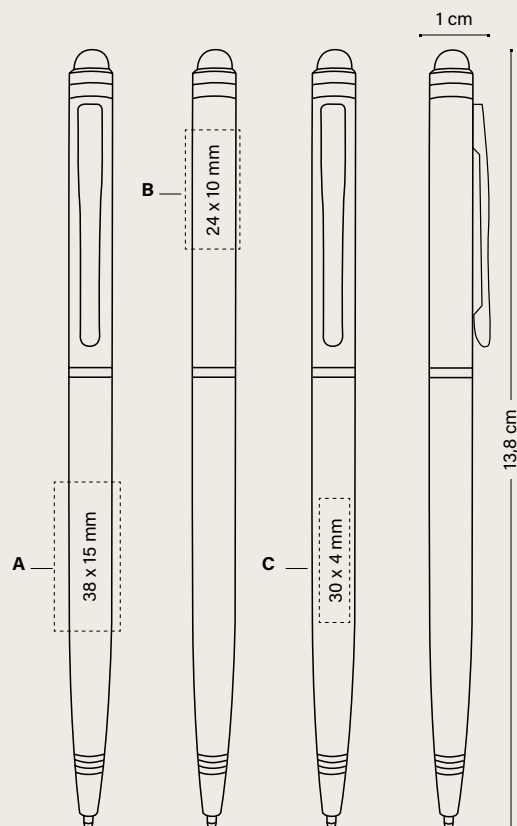

SLEEK STYLUS PEN	100-249	250-499	500-999	1000-2499	2500-4999	5000
11666						
Neutro	1,93	1,85	1,78	1,71	1,66	1,60
SP	-	2,55	2,34	2,15	2,09	1,94
LE	3,85	3,26	3,01	2,83	2,74	2,71

SLEEK STYLUS MATT PEN / EXECUTIVE PEN

11747 / 11976

Neutro	2,07	1,98	1,90	1,81	1,76	1,71
SP	-	2,68	2,46	2,26	2,19	2,05
LE	3,99	3,40	3,12	2,93	2,85	2,82

Costo di stampa aggiuntivo per colore e posizione

SP	-	0,39	0,34	0,23	0,23	①
LE	1,91	1,41	1,22	1,11	1,08	①

I prezzi includono una stampa in una posizione secondo la tecnica specificata.

① Prezzo su richiesta.

IMBALLAGGIO ESTERNO



MODALITÀ DI SCRITTURA



PENNA A SFERA M
Ø 1 MM

TECNICHE DI STAMPA



SERIGRAFIA



LASER

Vedere pagina 250 per una spiegazione dettagliata delle icone.

Tabella dei Contenuti

03

QUADERNI

ROCKETBOOK®

Rocketbook® Core Executive A5	194
Rocketbook® Fusion Executive A5	196
Rocketbook® Core Mini A6	198



ROCKETBOOK®

Rocketbook® combina la libertà di un tradizionale taccuino di carta e penna a sfera con la sua app per inviare in modo veloce e sicuro gli appunti scritti a mano alla tua cartella Cloud. È stato progettato per essere l'ultimo quaderno di cui avrai bisogno. Segui le istruzioni incluse per potere riutilizzare la pagina tutte le volte che vorrai. È possibile scegliere tra il modello Core per prendere appunti, tracciare grafici o disegnare, oppure fare un passo avanti con il modello Fusion per pianificare, elencare o fissare obiettivi.

ROCKETBOOK® CORE EXECUTIVE A5

ROCKETBOOK® FUSION EXECUTIVE A5

ROCKETBOOK® CORE MINI A6



ROCKETBOOK® CORE EXECUTIVE A5

NUOVO!

MOQ RIDOTTO A 25 PZ!



ROCKETBOOK® CORE EXECUTIVE A5
3728



07
●
Navy blu



01
○
Bianco



02
●
Nero

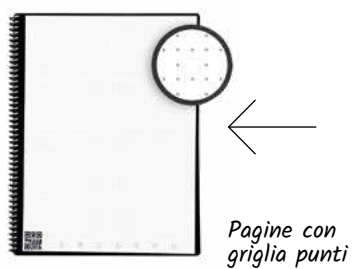
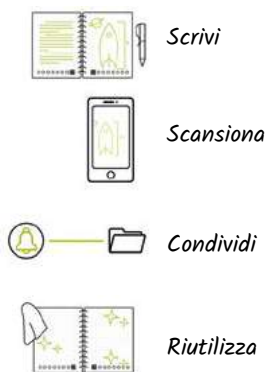

La confezione comprende sempre:
- quaderno
- penna cancellabile
- panno
- istruzioni

Personalizzazione

ROCKETBOOK® CORE EXECUTIVE A5

3728

A SP: max. 1 col.

B BP: full-colour

C HS: max. 1 col.

36 pagine

MOQ 25 pz.

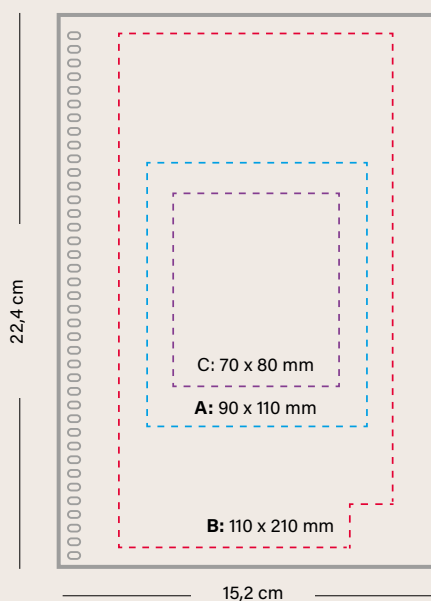

Prezzo (€)

ROCKETBOOK® CORE EXECUTIVE A5	25-49	50-99	100-249	250-499	500-999	1000
3728						
SP	38,52	35,02	32,76	29,81	28,08	27,21
HS	39,18	35,62	33,17	30,09	28,32	27,65
BP	44,05	40,05	35,72	32,60	30,68	29,01

I prezzi includono una stampa in una posizione secondo la tecnica specificata.

CONFEZIONI SPECIALI



GIFT BOX CORE A5

IMBALLAGGIO ESTERNO



50 ± 5,8 KG



STAMPATO NEGLI STABILIMENTI BIC



CONFORMITÀ NORMATIVA



IMPRIM'VERT®

APP ROCKETBOOK® DISPONIBILE IN



TECNICHE DI STAMPA



SERIGRAFIA



BRITEPIX™



HOT STAMPING



SCARICA L'APP



COME FUNZIONA

Vedere pagina 250 per una spiegazione dettagliata delle icone.

ROCKETBOOK® FUSION EXECUTIVE A5

NUOVO!

MOQ RIDOTTO A 25 PZ!



ROCKETBOOK® FUSION EXECUTIVE A5

372



01
○
Bianco

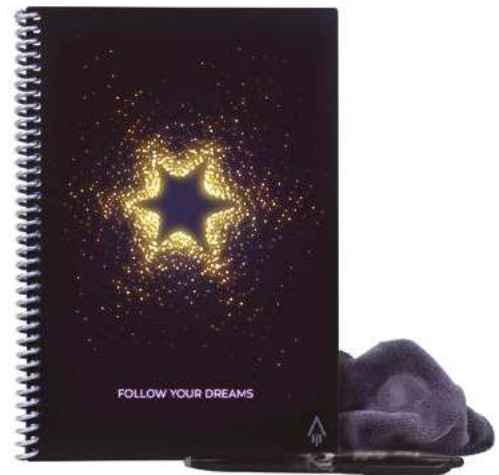

02
●
Nero

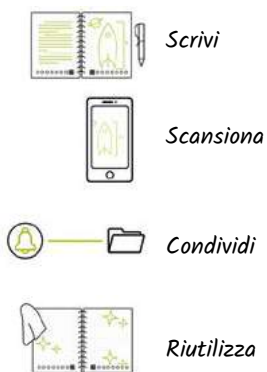

7 stili di pagina

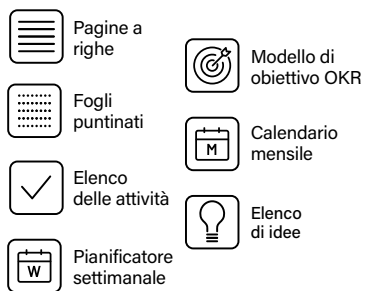

Personalizzazione visibile nella finestra ritagliata



La confezione comprende sempre:
- quaderno
- penna cancellabile
- panno
- istruzioni

Personalizzazione

ROCKETBOOK® FUSION EXECUTIVE A5

3726

A SP: max. 1 col.

B BP: full-colour

C HS: max. 1 col.

42 pagine

MOQ 25 pz.

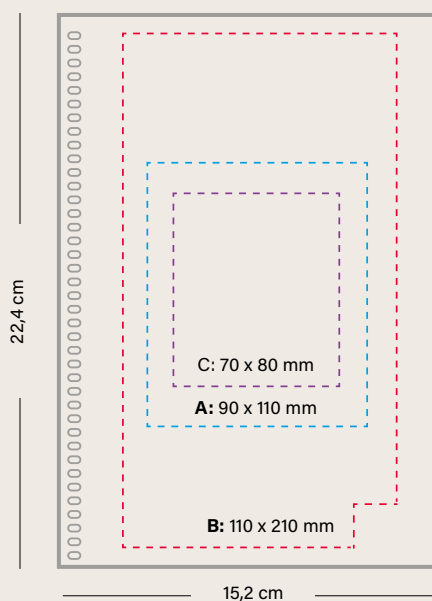

Prezzo (€)

ROCKETBOOK® FUSION EXECUTIVE A5	25-49	50-99	100-249	250-499	500-999	1000
3726						
SP	41,19	37,44	35,72	33,64	32,00	31,00
HS	41,85	38,05	36,12	33,97	32,21	31,20
BP	47,90	43,52	39,18	36,06	33,95	32,52

I prezzi includono una stampa in una posizione secondo la tecnica specificata.

CONFEZIONI SPECIALI



GIFT BOX FUSION A5

IMBALLAGGIO ESTERNO



50 ± 5,8 KG



APP ROCKETBOOK® DISPONIBILE IN



TECNICHE DI STAMPA



SERIGRAFIA



BRITEPIX™



HOT STAMPING



SCARICA L'APP



COME FUNZIONA

Vedere pagina 250 per una spiegazione dettagliata delle icone.

ROCKETBOOK® CORE MINI A6

NUOVO!

MOQ RIDOTTO A 25 PZ!



ROCKETBOOK® CORE MINI A6
3727



01
○
Bianco



02
●
Nero

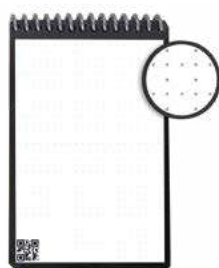

←
*Pagine con
griglia punti*



←
*Personalizzazione
visibile nella finestra
ritagliata*

La confezione comprende sempre:
- quaderno
- penna cancellabile
- panno
- istruzioni

Personalizzazione

ROCKETBOOK® CORE MINI A6

3727

A SP: max. 1 col.

B BP: full-colour

C HS: max. 1 col.

48 pagine

MOQ 25 pz.

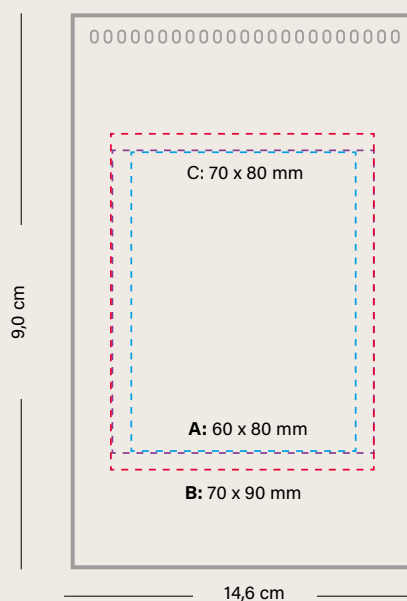

Prezzo (€)

ROCKETBOOK® CORE MINI A6	25-49	50-99	100-249	250-499	500-999	1000
3727						
SP	21,31	19,37	18,03	16,29	14,93	14,51
HS	21,78	19,80	18,43	16,56	15,61	15,03
BP	26,85	24,41	21,49	18,03	16,55	15,82

I prezzi includono una stampa in una posizione secondo la tecnica specificata.

CONFEZIONI SPECIALI



GIFT BOX
CORE A6

IMBALLAGGIO ESTERNO



50 ± 2,6 KG



STAMPATO NEGLI
STABILIMENTI BIC



CONFORMITÀ
NORMATIVA



APP ROCKETBOOK®
DISPONIBILE IN



TECNICHE DI
STAMPA



SERIGRAFIA



BRITEPIX™



HOT STAMPING



SCARICA L'APP



COME FUNZIONA

Vedere pagina 250 per una spiegazione dettagliata delle icone.

Tabella dei Contenuti

04

COVER BIC® STYL'IT LUXURY

COVER BIC® STYL'IT LUXURY 2386 Neon



TUTTE LE COVER
vengono consegnate
con un accendino
BIC® J25 bianco!



59



1G



5C

100%

Personalizzazione

COVER BIC® STYL'IT LUXURY 2386

MOQ 100 pz.
A/C LE

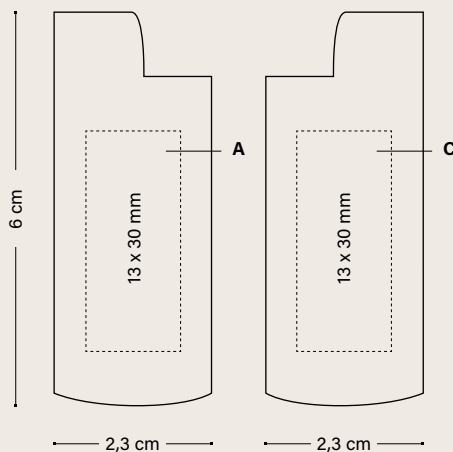

MOQ 100 pz.
A/C PD

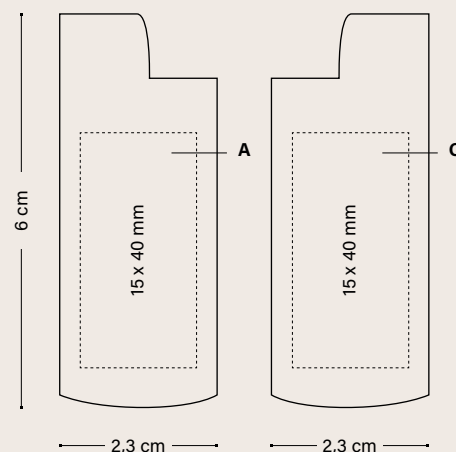

	Prezzo (€)			
COVER BIC® STYL'IT LUXURY NEON	100-299	300-599	600-1199	1200-2999
2386				
PD	3,02	2,66	2,52	2,39
LE	4,31	4,11	3,85	3,72

Costo di stampa aggiuntivo per colore e posizione

PD	0,29	0,25	0,18	0,18
LE	1,21	1,09	0,96	0,96

I prezzi includono una stampa in una posizione secondo la tecnica specificata.

CONFEZIONI



CONFEZIONI ESTÁNDAR:
EN BARQUETA DE 10 U.

IMBALLAGGIO ESTERNO



300 ± 6,1 KG



FSC E CARTONE
RICICLABILE



STAMPATO NEGLI
STABILIMENTI BIC



CONFORMITÀ
NORMATIVA



TECNICHE DI STAMPA



STAMPA A
TAMPONE



LASER

COVER BIC® STYL'IT LUXURY
2153 Soft



TUTTE LE COVER
vengono consegnate
con un accendino
BIC® J25 bianco!



100%

47

Personalizzazione

COVER BIC® STYL'IT LUXURY

2153

A/C LE

MOQ 100 pz.

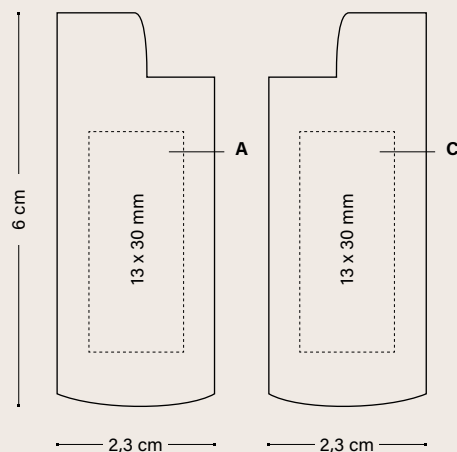

	Prezzo (€)			
	100-299	300-599	600-1199	1200-2999
COVER BIC® STYL'IT LUXURY SOFT				
2153				
LE	4,52	4,37	4,18	4,02
Costo di stampa aggiuntivo per colore e posizione				
LE	1,21	1,09	0,96	0,96

I prezzi includono una incisione laser in una posizione.

CONFEZIONI



CONFEZIONI ESTÁNDAR:
EN BARQUETA DE 10 U.

IMBALLAGGIO ESTERNO



300 ± 6,1 KG



FSC E CARTONE
RICICLABILE



STAMPATO NEGLI
STABILIMENTI BIC



CONFORMITÀ
NORMATIVA



TECNICHE DI STAMPA



LASER

COVER BIC® ALUMINIUM FLAT

COVER BIC® ALUMINIUM FLAT 2156

3 lati
personalizzabili!



TUTTE LE COVER
vengono consegnate
con un accendino
BIC® J25 bianco!



100%

47

Personalizzazione

COVER BIC® ALUMINIUM FLAT 2156

MOQ 100 pz.
A/C PD: max. 1 col.

MOQ 100 pz.
A/B/C BP: full-colour

MOQ 100 pz.
A/B/C LE

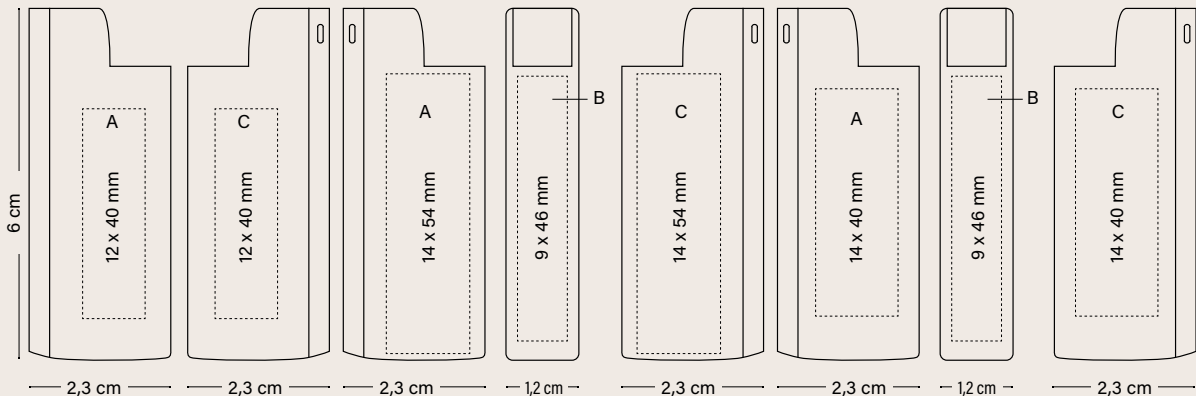

COVER BIC® ALUMINIUM FLAT 2156	Prezzo (€)			
	100-299	300-599	600-1199	1200-2999
PD	1,93	1,85	1,76	1,67
BP	2,14	2,06	1,95	1,86
LE	3,10	2,93	2,71	2,63

Costo di stampa aggiuntivo per colore e posizione

PD	0,29	0,25	0,18	0,18
BP	0,25	0,22	0,20	0,19
LE	1,21	1,09	0,96	0,96

I prezzi includono una stampa in una posizione secondo la tecnica specificata.

CONFEZIONI



CONFEZIONI ESTÁNDAR:
EN BARQUETA DE 50 U.

IMBALLAGGIO ESTERNO



300 ± 6,9 KG



FSC E CARTONE
RICICLABILE



STAMPATO NEGLI
STABILIMENTI BIC



CONFORMITÀ
NORMATIVA



TECNICHE DI STAMPA



STAMPA A
TAMPONE



BRITEPIX™
BRITEPIX™ PERSONALISATION

COVER BIC® CLIP 2398



TUTTE LE COVER
vengono consegnate
con un accendino
BIC® J25 bianco!



03



02

100%



Personalizzazione

COVER BIC® CLIP 2398

MOQ 100 pz.
A/C PD: max. 1 col.

MOQ 100 pz.
A/C BP: full-colour
BP Texture: full-colour

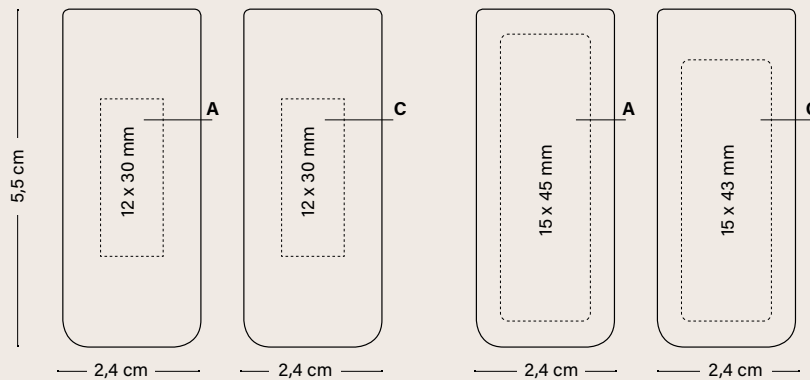

COVER BIC® CLIP 2398	Prezzo (€)			
	100-299	300-599	600-1199	1200-2999
PD	1,55	1,44	1,32	1,29
BP	1,76	1,65	1,52	1,47

Costo di stampa aggiuntivo per colore e posizione

PD	0,29	0,25	0,18	0,18
BP	0,25	0,22	0,20	0,19
BP Texture	0,19	0,17	0,15	0,14

I prezzi includono una stampa in una posizione secondo la tecnica specificata.

CONFEZIONI



CONFEZIONI ESTÁNDAR:
EN BARQUETA DE 50 U.



300 ± 7,5 KG



FSC E CARTONE
RICICLABILE



STAMPATO NEGLI
STABILIMENTI BIC



CONFORMITÀ
NORMATIVA



TECNICHE DI STAMPA



STAMPA A
TAMPONE



BRITEPIX™
BRITEPIX™ PERSONALISATION

COVER BIC® 3D 2395



*Tutte le cover
vengono consegnate
con un accendino
BIC® J25 bianco!*



*Converti il tuo logo
in una forma 3D!*

Personalizzazione

COVER BIC® 3D

2395

A/C 3D: max. 6 col.

MOQ 1.200 pz.

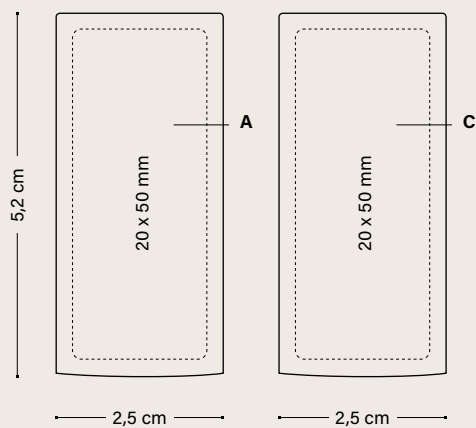

	Prezzo (€)		
COVER BIC® 3D	1200-2999	3000-5099	5100
2395			
3D	4,79	4,53	4,31

Costo di stampa aggiuntivo per colore e posizione

Stampa 3D in rilievo sul lato C (1 colore)	0,17	0,15	0,15
Colori in rilievo aggiuntivi	0,10	0,09	0,09

I prezzi includono la stampa 3D ad un colore in una posizione.

CONFEZIONI



CONFEZIONI ESTÁNDAR:
EN BARQUETA DE 50 U.

IMBALLAGGIO ESTERNO



300 ± 7,5 KG



FSC E CARTONE
RICICLABILE



CONFORMITÀ
NORMATIVA



TECNICHE DI
STAMPA



3D
EMBOSSING

POSACENERE TASCABILE BIC®

POSACENERE TASCABILE BIC®
3850

6 diverse forme
di linguetta
disponibili

Riutilizzabile ed
ermetico



Personalizzazione

POSACENERE TASCABILE BIC®
3850

A SP: max. 5 col. (max.2 colori per ordini inferiori a 20.000 pz.)

MOQ 5.000 pz.

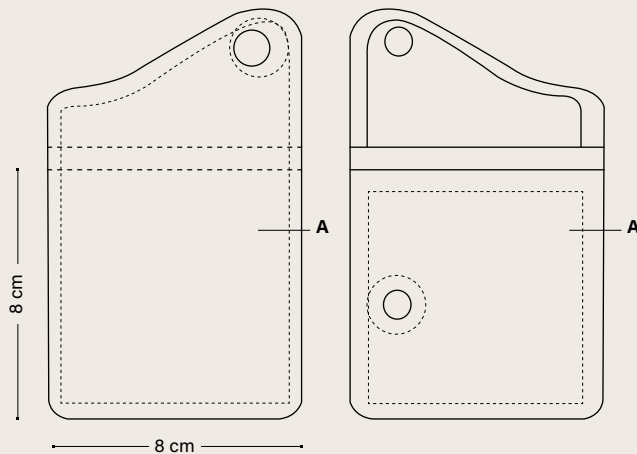

	Prezzo (€)			
	5000-9000	10000-24999	25000-49999	50000
POSACENERE TASCABILE BIC®				
3850				
SP	1,02	0,89	0,74	0,67

Costo di stampa aggiuntivo per colore e posizione

SP	0,04	0,03	0,03	0,03
-----------	------	------	------	------

I prezzi includono la serigrafia ad un colore in una posizione e il testo legale.

CONFEZIONI



SCATOLA PER 10 PZ. OGNI POSACENERE TASCABILE BIC® VIENE FORNITO IN UN CELLOPHANE INDIVIDUALE.

IMBALLAGGIO ESTERNO



500 ± 5,5 KG

MARCATURA



CONFORMITÀ
NORMATIVA

TECNICHE DI STAMPA



SERIGRAFIA

POSACENERE TASCABILE BIC®
3851 Kraft

*Immagine rispettosa
dell'ambiente*



100%

6F

Personalizzazione

**POSACENERE TASCABILE
KRAFT BIC®**

3851 Kraft

A SP: max. 2 col.

MOQ 10.000 pz.

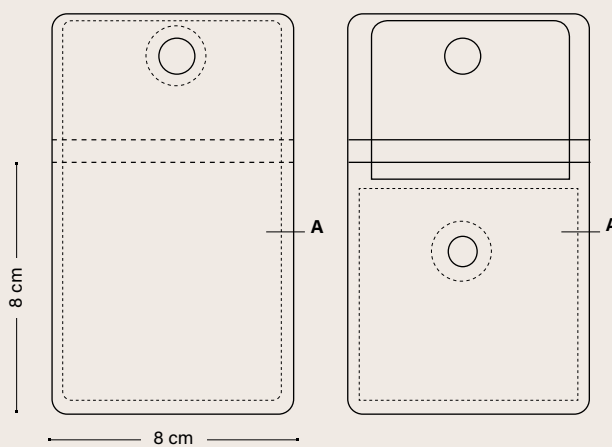

	Prezzo (€)		
POSACENERE TASCABILE BIC®	10000-24999	25000-49999	50000
3851			
SP	1,09	0,890	0,84

Costo di stampa aggiuntivo per colore e posizione

SP	0,03	0,03	0,03
-----------	------	------	------

I prezzi includono la serigrafia ad un colore in una posizione e il testo legale.

CONFEZIONI



SCATOLA PER 10 PZ. OGNI POSACENERE TASCABILE BIC® VIENE FORNITO IN UN CELLOPHANE INDIVIDUALE.

IMBALLAGGIO ESTERNO



500 ± 5,5 KG

MARCATURA



CONFORMITÀ
NORMATIVA

TECNICHE DI STAMPA



SERIGRAFIA



Tabella dei contenuti

05

CONFEZIONI BIC®

Confezioni BIC® Ecolutions®
Confezioni BIC®

240
242

CONFEZIONI BIC® ECOLUTIONS®



BIC® COLLECTION BOX

Scatola in cartone FSC. Personalizzabile su ogni lato, offre grandi superfici di comunicazione. Ideale per presentare i nostri iconici prodotti BIC® in una collezione. Più che una penna, un ottimo modo per ottimizzare le tue vendite.

	Prezzo (€)					
	100-249	250-499	500-999	1000-2499	2500-4999	5000
991212 1 unità	10,16	4,39	2,82	1,86	1,39	1,22
991213 2 unità	11,94	5,42	3,93	2,64	1,90	1,84
991214 3 unità	12,49	6,24	4,20	3,20	2,65	2,51

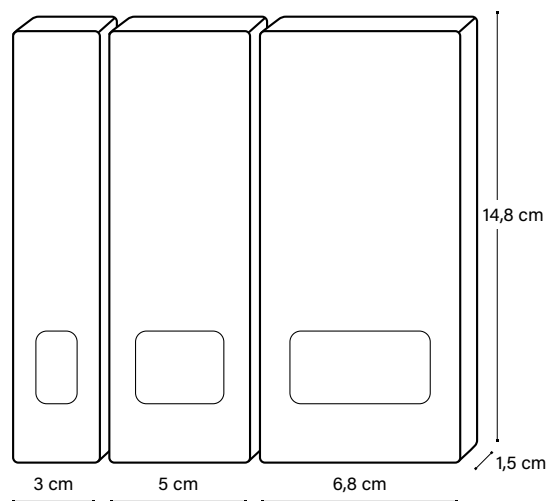

Confezione speciale per:



- BIC® 4 COLOURS®
- BIC® WIDE BODY™
- BIC® SUPER CLIP
- BIC® BRITE LINER® GRIP
- BIC® GRIP ROLLER



BIC® ECO SLEEVE

985240

Astuccio riciclato opzionale per tutti gli strumenti di scrittura BIC® eccetto le matite.



Prezzo (€)
0,25



Confezione speciale per penne con clip stampata:



- BIC® MEDIA CLIC
- BIC® CLIC STIC
- BIC® SUPER CLIP
- BIC® WIDE BODY™
- BIC® INTENSITY® GEL CLIC
- BIC® XS FINE STYLE

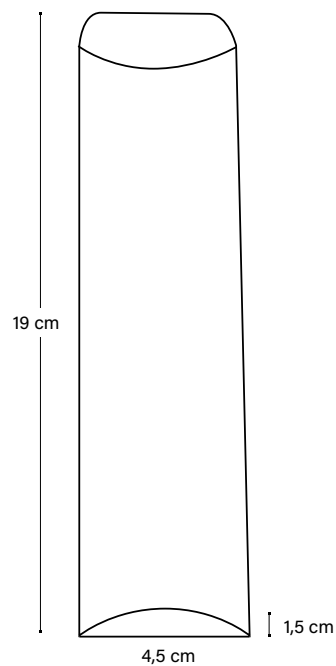

BIC® WINDOW BOX

985241

Astuccio dal design premiun adatto a tutti gli strumenti di scrittura BIC® eccetto le matite.



FSC E CARTONE RICICLABILE

Prezzo (€)
1,48

2,2 cm

2,2 cm

18,7 cm

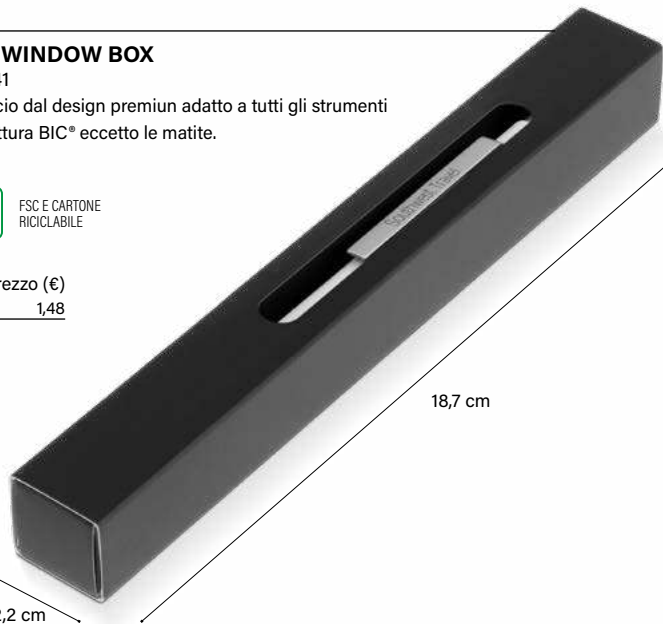

Confezione speciale per:



BIC® METAL PENS

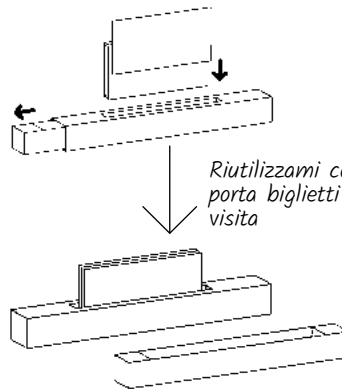

Riutilizzami come porta biglietti da visita

BIC® PLASTIC POUCH

985242

Design speciale per questa confezione adatta per ogni strumento di scrittura e per 3 matite.

Prezzo (€)
0,46



FSC E CARTONE RICICLABILE



PLASTICA RICICLABILE



Usami come segnalibro



19,6 cm

4,6 cm

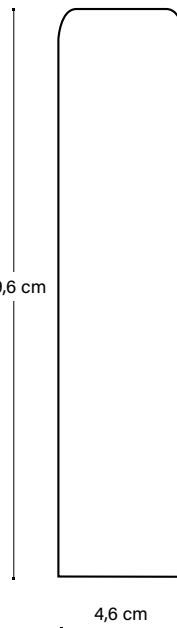

BIC® MARKING SET

985243

Confezione adatta a ogni pennarelli.

Prezzo (€)
0,73



FSC E CARTONE RICICLABILE



PLASTICA RICICLABILE



16 cm

6,3 cm

Confezione speciale per:



3 BIC® BRITE LINER® GRIP
3 BIC® MARK-IT



3 BIC® VELLEDA® GRIP
3 BIC® VELLEDA® FINE

Usami come segnalibro



PRODOTTO IN SPAGNA



CONFORMITÀ NORMATIVA



ecolutions®

BIC® CELLO WRAP

971634 / 971635 / 971636 / 971637

Confezioni in plastica trasparente.



Cello wrap 1 unità



Cello wrap 2 unità

BIC® CELLO WRAP	Prezzo (€)
1 unità - 971634	0,19
2 unità - 971635	0,36
3 unità - 971636	0,52
4 unità - 971637	0,70

1 unità - 971634

Prezzo (€)

2 unità - 971635

0,36

3 unità - 971636

0,52

4 unità - 971637

0,70

Non disponibile per matite in grafite né per penne metalliche.

BIC® BLACK VELVET POUCH 1 UNITÀ

974216

Esclusiva confezione in velluto per 1 o 2 strumenti di scrittura.

Particolarmente indicata per penne in metallo.

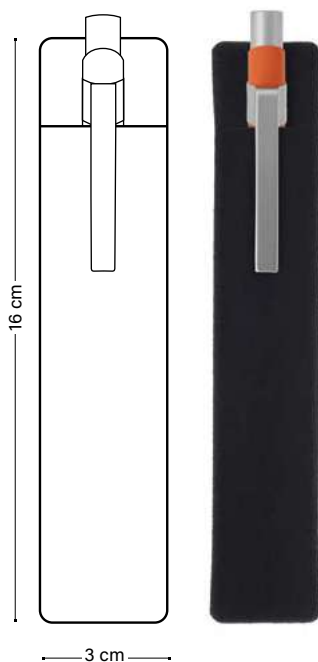

BIC® BLACK VELVET POUCH 1 UNITÀ	Prezzo (€)
1 unità	0,53

1 unità

Prezzo (€)

0,53

Disponibile per tutti gli strumenti di scrittura eccetto matite in grafite e portamine.

**BIC® CARTON BLACK&SILVER
COLOUR GIFT BOX**

974218

Scatoletta per tutti gli strumenti di scrittura, matite escluse.

Prezzo (€)
0,36

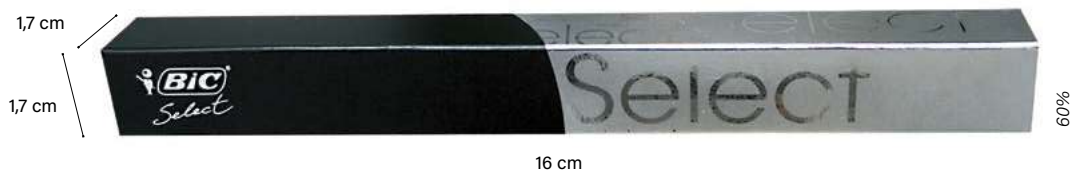

BIC® FROSTED POUCH (PER 1 O 2 UNITÀ)

971640

Confezione trasparente per 2 strumenti di scrittura.

A SP: max. 1 col.

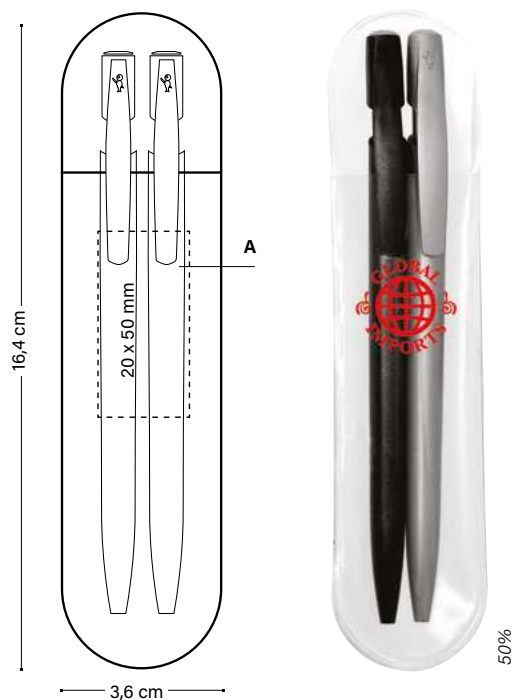

BIC® FROSTED POUCH Prezzo (€) 0,90

Costo di stampa aggiuntivo per colore e posizione

SP 0,48

Disponibile per 1 o 2 strumenti di scrittura (sottili) BIC®
eccetto: matite in grafite e portamine.

SP SERIGRAFIA

**BIC® SEE-THROUGH GIFT BOX
(PER 1 O 2 UNITÀ)**

974599

Scatoletta per tutti gli strumenti di
scrittura, matite escluse, con finestrella.

Prezzo (€)
2,03

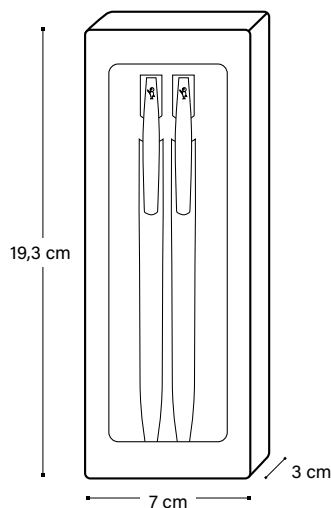

COUNT BOX

Piccola (per 25 BIC® Clic Stic) - 6 x 6,2 x 14 cm
971639

Media (per 50 BIC® Media Clic o strumenti di scrittura delle stesse dimensioni) - 7,5 x 7,5 x 15,2 cm
971638

Grande (solo per 100 BIC® Ecolutions® Evolution) - 7,5 x 7,5 x 19 cm
971672

	Prezzo (€)
Piccola	
971639	0,88
Media	
971638	1,23
Grande	
971672	1,69

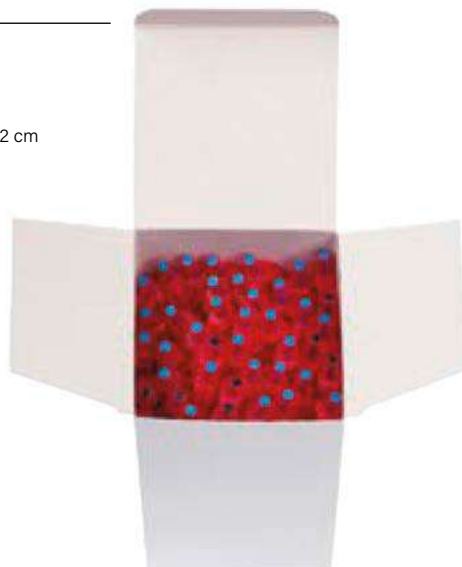

PLASTIC BAG

Piccola (per 25 BIC® Media Clic o strumenti di scrittura delle stesse dimensioni)
971644 - 12 x 18 cm

Media (per 50 BIC® Media Clic o strumenti di scrittura delle stesse dimensioni)
971643 - 15 x 22 cm

Grande (per 100 BIC® Media Clic o strumenti di scrittura delle stesse dimensioni)
971642 - 30 x 40 cm

	Prezzo (€)
Piccola	
971644	0,60
Media	
971643	1,16
Grande	
971642	1,74



TRAY OF 10 WRITING INSTRUMENTS

974590

Prezzo (€)
1,97

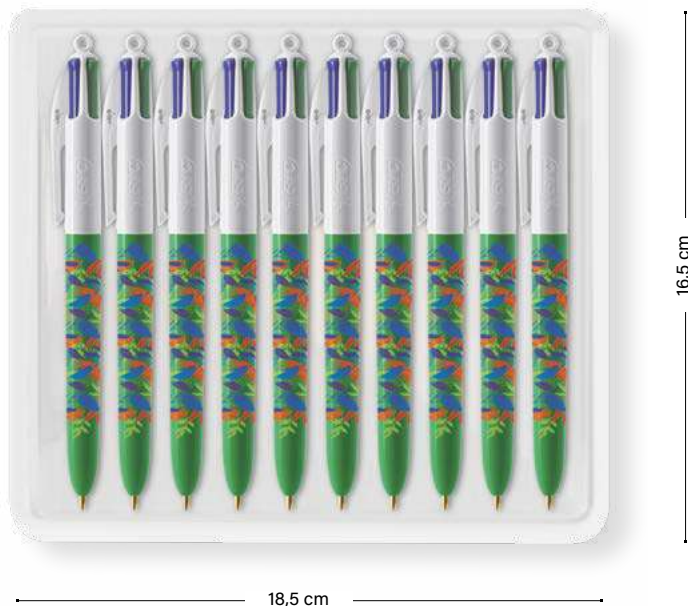

COUNT BOX 10U. COVER

976382

Prezzo (€)
1,03

Disponibile per Accendini BIC® J26, BIC® J38, BIC® J23 e BIC® J25.



COUNT BOX 10U. COVER CHILD RESISTANT

976403

Prezzo (€)
1,03

Disponibili per Accendini BIC® J26, BIC® J38, BIC® J23 e la famiglia Cover BIC® Styl'it Luxury.



COUNT BOX 10U. J25 CHILD RESISTANT

974635

Prezzo (€)
0,80

Disponibile per accendino BIC® J25.



BOX OF 50U. METAL STYL'IT COVER

977852

Prezzo (€)
4,61

Disponibile per Cover BIC® Clip, Cover BIC® 3D e Cover BIC® Flat



TRAY OF 50 BIC® LIGHTERS



TRAY OF 10 BIC® LIGHTERS

FSC E CARTONE RICICLABILE



BIC® OUTER BOXES

Cartone esterno con design speciale per tutti gli strumenti di scrittura.



FSC E CARTONE RICICLABILE



PRODOTTO IN SPAGNA



FSC E CARTONE RICICLABILE



PRODOTTO IN SPAGNA



DJEEP® OUTER BOXES

Disegno speciale per la scatola di accendini.



FSC E CARTONE RICICLABILE



PRODOTTO IN FRANCIA

Tabella dei contenuti

INFORMAZIONI GENERALI

Ordina con facilità!	248
Simboli e abbreviazioni	250
Informazioni generali	252
Indice prodotti	253
Tavolozza dei colori	254

RISPARMIA TEMPO QUANDO CALCOLI IL PREZZO FINALE

GUARDA LA COLONNA QUANTITÀ E HAI GIÀ IL
TUO PREZZO!

NESSUN COSTO DI IMPIANTO

PERSONALIZZAZIONE INCLUSA

Il prezzo comprende la personalizzazione in una posizione.

COLORI SPECIALI PER I PARTICOLARI

- Una illimitata scelta di colori per il corpo e i particolari delle tue penne per ordini a partire da 10.000 pezzi.
- Una penna completamente personalizzata con qualsiasi colore desiderato.
- Disponibile su un'ampia gamma di prodotti.
- Un servizio di grande valore con solo un piccolo aumento dei tempi di produzione.
- Disponibile per fusto e particolari di: BIC® Round Stic®, BIC® Media Clic, BIC® Media Clic Grip*, BIC® Clic Stic, BIC® Super Clip, BIC® Wide Body™**, BIC® XS Finestyle.

*MOQ per corpo e grip personalizzati: 20.000 pezzi

Costo di set up per ordine	1.100 €
Costo di set up per ordine (riassortimento)	660 €
Costo di set up per ordine oltre le 100.000 unità	Gratuito

COSTI AGGIUNTIVI

CAMPIONE PRE-PRODUZIONE (TRASPORTO ESCLUSO)	
> Disponibile per strumenti di scrittura (10 unità), BIC® Lighters (10 unità)	145 €/ordine*
> Costo cambio colore refill dove possibile	0,18 €/unità
> Cancellazione e/o modifiche dopo approvazione della bozza (saranno soggetti all'accettazione di BIC Graphic Europe)	
> Costo fisso per ogni modifica	85 €/ordine
> Personalizzazione individuale britePix™	75 €/ordine**

COSTI AGGIUNTIVI

*Non disponibile su accendini digitali con Puffy, Puffy Glitter, Metallic, Holographic e finiture UV.

**La personalizzazione individuale in britePix™ consente di modificare i testi e le immagini della vostra bozza dando una stampa personalizzata per ciascuno dei prodotti nel vostro ordine. Sia i testi sia le informazioni relative alle modifiche di immagini dovranno essere forniti in un file Excel. In caso di cambiamenti nel posizionamento dei testi e delle immagini, è previsto un costo aggiuntivo.

Per termini e condizioni di vendita consultare gentilmente: www.bicgraphic.com

INFORMAZIONE SUI FILE:

Sempre, per quanto riguarda i file, i documenti si devono inviare come di seguito:

- un file elettronico con il design grafico (artwork)
- ed un altro file separato per il testo. Per un'incisione a laser singola, consegnare i testi esclusivamente in formato Excel® (.xls).

PROPRIETÀ DEL MATERIALE GRAFICO

Inviateci il vostro materiale grafico in uno dei seguenti tipi di file:

- JPG / 350 dpi non compresso e nel formato reale della stampa (solo per le immagini, non per il testo)
- PDF / vettoriale
- Illustrator® CC / vettoriale
- Photoshop® CC / con livelli
- file ZIP

E' importante che le informazioni vengano mandate in uno dei formati indicati al fine di sveltire l'ordine ed ottenere un miglior risultato finale. Nel caso in cui il design del cliente non si adattasse all'area di stampa, verrà adattato di conseguenza.

CARATTERI:

Tutti i caratteri devono essere convertiti in immagine. Verificare le dimensioni minime del carattere e gli spessori del tratto.

SPECIALE PER PRODOTTI DI SCRITTURA

SERIGRAFIA

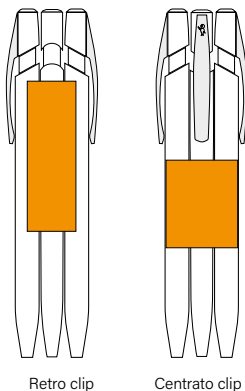

Retro clip

Centrato clip



L'area di stampa disponibile dipende dalla tecnica desiderata.

SPECIALE PER ACCENDINI DIGITALI (J25, J23, J26 E J38)



Se si desidera un colore preciso, potrebbe essere scelto un quinto colore dalla suddetta guida a un costo aggiuntivo. Per maggiori informazioni sulla migliore corrispondenza del colore di stampa per i vari prodotti del nostro catalogo, contattare il nostro Servizio Clienti.

Simboli & abbreviazioni

OPZIONI SPECIALI

- PG** **Puffy glitter**
Texture con glitter colorati.
- P** **Puffy**
Una personalizzazione evidenziata con il nostro inchiostro "Puffy" per dare un effetto a rilievo al tuo logo.
- BR** **BR**
Finitura brillante.
- M** **Finitura metallica**
Crea effetti, immagini sfondi metallici. Il tuo marchio sarà inconfondibile
- H** **Finitura olografica**
Trasforma il tuo logo in un'immagine tridimensionale con gli ologrammi. Rende il tuo messaggio straordinario.
- MT** **Matte**
Finitura opaca.
- UV** **UV**
Finitura lucida.
- HS** **Hot Stamping**
Rilievo tattile
-  **Stampa a 360° penna a sfera**
-  **Stampa a 360° accendino**
-  **Digital**
Alta definizione - stampa in digitale in quadricromia, 360° gradi su tutta la lunghezza del corpo.
-  **britePix™ Digital**
La soluzione per la comunicazione a tutto colore. Ora sui fusti colorati.
-  **britePix™ Texture**
britePix™ Texture è un salto di qualità nel nostro concetto di stampa britePix™ - ora non solo puoi vedere il colore pieno, ma puoi anche toccarlo!
-  **britePix™ personalisation**
Personalizzazione britePix™. Personalizza ogni unità dello stesso ordine britePix™.

- SP** **Serigrafia**
- LE** **Incisione laser**
- PD** **Stampa a tampone**
- DG** **Digitale**

- BP** **britePix™**
- 3D** **3D Rilievo**
- TF** **Touch & feel**
- ET** **Etched**
- GM** **Glossy & matt mix**
- FI** **Fragrant ink**
- QR** **QR code**
- BL** **Black light**
- FA** **Fabric**
- RC** **Resin chip**
- GR** **Granite**
- GD** **Glow in the dark**
- H** **Holographik®**
- PE** **Pearlescent**
- ST** **Djeeep® soft touch®**
- GT** **Glittering**
- HM** **Hammered metal**





MODALITÀ DI SCRITTURA

-  **Penna a sfera** | M Medium 1 mm
F Fine
-  **Portamine MP**
-  **Matita PC**
-  **Roller R**
-  **Evidenziatore HL**
-  **Stylus Pen SP**
-  **Scrittura Finestyle Ø 0,7mm FS**
-  **Gel G**
-  **Pennarello MK**
-  **Punta resistente**
-  **Non si scheggia**
-  **Facile da usare e da cancellare**
-  **Scrittura più delicata e scura**
-  **Scrittura più delicata e fluida**
-  **Resistente agli urti**
-  **Non si secca**
-  **Proteggi mina**
-  **2 mine**

COLORI D'INCHIOSTRO







- Nero
- Verde chiaro
- Azzurro
- Verde
- Blu
- Verde mela
- Rosso
- Fluo
- Arancio
- Rosa
- Giallo
- Viola



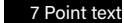

ALTRI SIMBOLI

	Nuovo!			93% di riduzione virale entro 24 ore
	Mix&Match Centinaia di colori dei componenti di produzione degli strumenti di scrittura per una personalizzazione completa			Protezione della superficie della penna a sfera
	Colori Personalizzati Scegli il colore PMS esatto che si adatta meglio al tuo logo.			Protezione permanente
	Prodotto e stampato negli stabilimenti BIC			Protezione batterica
	Prodotto negli stabilimenti BIC			Inibizione di funghi 24 ore
	Stampato negli stabilimenti BIC			Conformità normativa
	Assemblaggio e stampa negli stabilimenti DJEEP			EN 13869 Normativa europea per accendini sulla sicurezza dei bambini.
	Assemblaggio e stampa negli stabilimenti BIC			Certificato ISO
	Qualità e sicurezza approvata			ISO Norme di sicurezza internazionali
	Paese d'origine			Numero di lame
	Fabbricato in Francia			QR code scannerizza il QR code e guarda il video
	Prodotto in Spagna			Informazioni sul packaging 250 ± 3,5 KG
		FSC e cartone riciclabile Certificazione della corretta gestione ambientale		DIMENSIONI: Le dimensioni pubblicate relative a ciascun prodotto corrispondono alla sua dimensione massima indipendentemente dalla posizione del disegno.
		Imballaggi farmaceutici		
		Vassoi di frutta e verdura		
		Frigoriferi e contenitori di yogurt		
		Canna da zucchero		
		Ubicuity Program Tutti gli strumenti da scrittura BIC lo sono riciclabile attraverso il nostro programma Ubicuity, una partnership con Terracycle. Per maggiori dettagli, visitare Terracycle all'indirizzo https://www.terracycle.com		
		Parti in plastica per autoveicoli		
		100 % elettricità da fonti rinnovabili Lo stabilimento BIC Graphic Europe funziona con elettricità proveniente 100% da fonti rinnovabili. Quindi i prodotti sono realizzati con elettricità al 100% rinnovabile.		
		IMPRIM'VERT®		
		Möbius Loop Il prodotto contiene materiale riciclato.		
		Basso impatto ambientale I prodotti sono realizzati e stampati in fabbriche Europee dove il 100% dell'elettricità utilizzata proviene da fonti rinnovabili.		

Informazioni Generali

PARAMETRI TECNICI PER CIASCUN TIPO DI STAMPA

	DIGITALE / TRASFERIMENTO - DIGITAL	
Testo positivo minimo	4 pt (1.4 mm)	
Testo negativo minimo	7 pt (2.4 mm)	
Valori minimi mezzo tono	1.5 pt (0.5 mm)	
Spessore minimo per linee positive	0.25 pt (0.08 mm)	
Spessore minimo per linee negative	0.5 pt (0.17 mm)	
Spessore minimo per mezzi toni	0.5 pt (0.17 mm)	
Percentuale mezzo tono	C: 8% / M: 8% / Y: 12% / K: 8%	

	britePix™	
Testo positivo minimo	6 pt (2.1 mm)	
Testo negativo minimo	7 pt (2.4 mm)	
Spessore minimo per linee positive	0.4 pt (0.14 mm)	
Spessore minimo per linee negative	0.5 pt (0.17 mm)	
Spessore minimo per mezzi toni	1 pt (0.35 mm)	
Percentuale mezzo tono		













	SERIGRAFIA/ STAMPA A TAMPONE	STAMPA A CALDO / BASSO RILIEVO	LASER
Testo positivo minimo	6 pt (2.1 mm) 	10 pt (3.5 mm) 	6 pt (2.1 mm) 
Testo negativo minimo	9 pt (3.1 mm) 	15 pt (5.25 mm) 	NON RACCOMANDATO
Spessore minimo per linee positive	0.4 pt (0.14 mm) 	1.5 pt (0.5 mm) 	0.3 pt (0.1 mm) 
Spessore minimo per linee negative	0.5 pt (0.176 mm) 	2 pt (0.706 mm) 	0.5 pt (0.17 mm) 
Spessore minimo per mezzi toni	1.5 pt (0.5 mm) 	NON POSSIBILE	NON POSSIBILE
Percentuale mezzo tono	50% 		

Tabella dei contenuti dei prodotti

STRUMENTI DI SCRITTURA BIC®

BIC® Style _____	46
BIC® Round Stic® _____	50
BIC® M10® Clic _____	56
BIC® Media Clic _____	58
BIC® Media Clic Grip _____	63
BIC® Media Clic BGuard™ antibacterial _____	67
BIC® Media Clic BGuard™ antimicrobial Ecolutions® _____	70
BIC® Media Clic Biobased Ecolutions® _____	72
BIC® Media Clic Biobased BGuard™ antibacterial _____	75
BIC® Media Clic Shine _____	77
BIC® Media Clic Glacé _____	78
BIC® Clic Stic _____	80
BIC® Clic Stic Stylus _____	84
BIC® Clic Stic Mini _____	84
BIC® Super Clip _____	88
BIC® Super Clip Advance _____	94
BIC® Super Clip Glacé _____	98
BIC® Super Clip Glacé Advance _____	98
BIC® Super Clip Soft _____	100
BIC® Super Clip Soft Advance _____	100
BIC® Super Clip Origin _____	102
BIC® Wide Body™ _____	104
BIC® 4 Colours® _____	112
BIC® 4 Colours® Bicolor _____	114
BIC® 4 Colours® Gradient _____	116
BIC® 4 Colours® Pastel _____	118
BIC® 4 Colours® Fashion _____	120
BIC® 4 Colours® Sun _____	122
BIC® 4 Colours® Fine _____	124
BIC® 4 Colours® Fluo _____	126
BIC® 4 Colours® Shine _____	128
BIC® 4 Colours® Glacé _____	130
BIC® 4 Colours® Soft _____	132
BIC® 4 Colours® Wood Style _____	134
BIC® 4 Colours® Flags Collection _____	136
BIC® 4 Colours® 3+1 ^{HB} _____	138
BIC® Metal Pro _____	140
BIC® Cristal® Re'New™ _____	145
BIC® Grip Roller _____	150
BIC® XS Finestyle _____	152
BIC® Intensity® Gel Clic _____	154
BIC® Brite Liner® Grip _____	158
BIC® Velleda® White Board Marker Fine _____	160
BIC® Velleda® White Board Marker Grip _____	161
BIC® Mark-It Permanent Marker _____	162
BIC® Permanent Marker Ecolutions® _____	163
BIC® Matic® _____	166
BIC® Media Clic Portamine _____	168
BIC® Media Clic Grip Portamine _____	169
BIC® Evolution® Ecolutions® _____	174
Sprout™ Matita di Grafite _____	178

ALTRI STRUMENTI DI SCRITTURA

Basic Pen _____	182
Click Pen _____	184
Striped Grip Pen _____	186
Sleek Stylus Pen _____	188

QUADERNI

Rocketbook® Core Executive A5 _____	194
Rocketbook® Fusion Executive A5 _____	196
Rocketbook® Core Mini A6 _____	198

ACCENDINI E COVER ACCENDINI BIC®

Accendino BIC® J25 _____	206
Accendino BIC® J23 _____	210
Accendino BIC® J26 _____	214
Accendino BIC® J38 _____	218
Cover BIC® Styl'it Luxury _____	222
Cover BIC® Aluminium Flat _____	224
Cover BIC® Clip _____	225
Cover BIC® 3D _____	226
Posacenere Tascabile BIC® _____	228

ACCENDINI DJEEP®

Accendino DJEEP® D1 _____	230
---------------------------	-----

PACKAGING BIC®

Confezioni BIC® Ecolutions® _____	240
Confezioni BIC® _____	242

Tavolozza dei colori

01 Bianco	1E Bianco eco	57 Bianco opaco	3C Bianco perla	01BIO Bianco Bio	1T Bianco polished	51 Trasparente	69 Bianco frosted	2E Bianco frosted riciclato	
8D Giallo pastello	8G Giallo light	12 Giallo	12W Legno giallo	63 Giallo frosted	6AW Legno naturale	012BIO Giallo BIO	4D Giallo clear	6F Marrone light	60 Naturale
26 Oro	76 Oro glacé	1G Arancio acido	10 Arancio	90 Arancio pastello	71 Arancio frosted	92 Arancio clear			
03 Rosso	03G Rosso glacé	03F Rojo soft	8E Rosso riciclato	87 Rosso clear	03BIO Rosso BIO	66 Rosso frosted	08 Borgogna		
14 Rosa	5C Rosa fizz	1P Rosa acido	014G Rosa glacé	07 Rosa dorato	11 Rosa	80 Rosa	97 Rosa dorato		
84 Viola pastello	13 Violetta	39 Viola frosted	7G Viola metallico	2D Viola scuro	93 Viola scuro clear	4B Viola frosted			
8C Lime	68 Verde frosted	6C Verde grass	88 Verde chiaro clear	59 Verde mela	82 Verde scuro frosted	72 Verde clear	5G Verde chiaro	05G Verde glacé	
05 Verde	05W Legno verde	20 Verde scuro	7E Verde scuro riciclato	88 Verde scuro clear	05BIO Verde Bio	3B Giungla frosted			
83 Azzurro pastello	3D Azzurro caraibico	86 Azzurro clear	67 Azzurro frosted	24 Azzurro light	04BIO Azzurro Bio	04 Azzurro	04G Blu	40 Blu scuro frosted	4R Blu turchese
34 Blu scuro metallico	89 Blu scuro clear	25 Blu scuro	07 Navy blu	07F Navy blue soft	10E Navy blu riciclato				
35 Cromato	47 Grigio	47G Argento glacé	75 Grigio metallico	18 Metallico	06 Grigio	27 Grigio scuro	8H Grigio scuro clear		
02BIO Nero Bio	02W Legno nero	02F Nero soft	02 Nero	3E Nero riciclato	2N Nero mate				